



Fire detection and evacuation solutions that save lives.



EvacU^{Elite} Emergency Warning & Intercom System (EWIS)

Install, Commission and User Manual

MAN3137-6

Contents

1	Certification Information.....	8
2	Purpose	9
2.1	Scope	9
2.2	References.....	9
2.2.1	EvacU ELITE System Manuals:	9
2.2.2	Compliance Standards -Australian.....	9
3	System overview	10
3.1	General.....	10
3.2	Access levels.....	10
3.3	Emergency warning control and indicating equipment.....	11
3.4	Emergency intercom control and indicating equipment.....	12
4	System Description	13
4.1	General.....	13
4.2	System Components	14
4.2.1	Universal Rack	14
4.2.2	Power Supply.....	16
4.2.3	Combo Systems - Power distribution.....	20
4.2.4	Graphical User Interface	21
4.2.5	Universal Rack Cards.....	22
4.2.6	Networking.....	28
4.2.7	Public Address Interface Card (PAIC)– Bosch Praesensa interface HLI	30
4.2.8	Remote Paging Console	33
5	EWCIE and EICIE Operation	34
5.1	Front Control Panel	34
5.1.1	General.....	34
5.1.2	Status Line (EWS and EIS).....	34
5.1.3	Automatic / Manual Mode control and Indication (EWS).....	35
5.1.4	Automatic mode control and indicator.....	35
5.1.5	Manual mode control and indicator	35
5.1.6	Networking Considerations.....	35
5.1.7	Test condition control (EWS).....	35
5.1.8	Silence warning control and indicator (EWS)	36
5.1.9	Reset control (EWS)	36
5.1.10	All controls and indicators (EWS)	36
5.1.11	All speech control and indicator	37
5.1.12	All alert control and indicator	37
5.1.13	All evac control and indicator	37
5.1.14	Silence buzzer control (EWS and EIS)	38
5.1.15	Delay override (EWS).....	38
5.1.16	All call control and indicator (EIS)	38
5.1.17	Menu control (EWS and EIS)	38
5.1.18	Individual EWS controls and indicators	39
5.1.19	Individual EIS controls and indicators.....	41
5.1.20	Remote control indicator.....	42
5.1.21	Network fault indicator	42
5.1.22	Talk indicator.....	42
5.1.23	EICIE in control indicator	42
5.2	Additional Front Panels (GUIs)	42
5.3	Led Indicators	43
5.3.1	Power	43

5.3.2	Power Fault	43
5.3.3	Fault	43
5.3.4	System Fault	43
5.3.5	Delays.....	43
5.3.6	Earth Fault	43
5.3.7	Disabled.....	43
5.3.8	Alarm.....	43
5.3.9	Test.....	43
5.4	EWS Operation	44
5.4.1	General.....	44
5.4.2	Live Speech	44
5.4.3	Automatic Operation	44
5.4.4	Delays.....	44
5.4.5	Silence	45
5.4.6	Reset	45
5.4.7	Manual Operation.....	45
5.4.8	Disabling Emergency Zones.....	45
5.4.9	To disable one or more emergency zones:	46
5.4.10	To view the disabled emergency zones	48
5.4.11	Activating the Test Tone	49
5.4.12	Test Condition	50
5.5	EIS Operation.....	51
5.5.1	General.....	51
5.5.2	Establish a call from the EICIE handset to a WIP handset.....	51
5.5.3	Establish a call from the WIP handset to the EICIE handset.....	52
5.5.4	Establishing a multi-party conference call	52
5.5.5	All Call broadcast.....	53
5.5.6	Networked EICIE	53
5.5.7	Ring, On Hold and Confidence Tones.....	54
5.6	Remote Paging Console.....	54
6	Menu System.....	55
6.1	General.....	55
6.2	Access levels	56
6.3	Nodes	57
6.3.1	Distribution CPU card.....	59
6.3.2	Network interface card	61
6.3.3	Multi-purpose interface card	62
6.3.4	Multi-purpose output card.....	64
6.3.5	Quad radial EIS line card (ILC).....	65
6.3.6	Dual loop EIS line card (LILC)	67
6.3.7	Dual 25-watt amplifier card.....	70
6.3.8	50Watt amplifier card	71
6.3.9	150-Watt Amplifier Card	71
6.3.10	Public Address Interface Card PAIC.....	72
6.3.11	Graphical user interface	73
6.3.12	Power supply.....	74
6.4	Zones	76
6.5	WIPs	77
6.6	Remote Paging Consoles	78
6.7	Alarms	79
6.8	Faults	80
6.9	Disables	82

6.10	Logs	83
6.11	Date and Time.....	84
6.12	Sequencing	86
6.13	Zone delay off/on.....	89
6.14	Access level.....	90
6.15	FAD retrigger	90
7	Installation.....	91
7.1	Unpacking and inspection	91
7.2	Ant-static precautions	91
7.3	Working on the system	91
7.4	Cabinet Installation	92
7.5	Mains termination	95
7.6	Fitting cards to the universal racks	96
7.7	Connecting the batteries.....	97
7.8	Recommended Batteries.....	98
8	Connecting to the Evacu ^{ELITE}	98
8.1.1	General.....	98
8.2	Distribution CPU	99
8.2.1	Connections.....	99
8.2.2	Indications	100
8.3	Multi-purpose output card (MOC).....	101
8.3.1	Connections.....	101
8.3.2	Indicators.....	103
8.3.3	Field wiring	104
8.4	Multi-purpose interface card (MIC)	106
8.4.1	Connections.....	106
8.4.2	Indications	107
8.5	Dual 25Watt amplifier.....	109
8.5.1	Connections.....	109
8.5.2	Indicators.....	110
8.5.3	Field wiring	111
8.6	50Watt amplifier.....	112
8.6.1	Connections.....	112
8.6.2	Indicators.....	113
8.6.3	Field wiring	114
8.7	150Watt amplifier.....	115
8.7.1	Field wiring	116
8.8	Quad radial EIS line card (ILC).....	117
8.8.1	Connections.....	117
8.8.2	Indicators.....	118
8.8.3	Field wiring	119
8.9	Dual loop EIS line card (LILC)	120
8.9.1	Connections.....	120
8.9.2	Indicators.....	121
8.9.3	Field wiring - Use of Ferrites on each Loop WIP card	121
8.10	PAIC Public Address Interface Card.....	123
8.10.1	PAIC -Network Switch Card Indications.....	123
8.10.2	PAIC -Network Switch Card Connections.....	123
8.10.3	PAIC Interface CSIRO Application Note	124
8.10.4	EvacuElite to Bosch Praesensa Connections	124
8.11	Network Interface Card.....	126
8.11.1	Connectors.....	126

8.11.2	Understanding EvacUElite Network fault conditions	127
8.11.3	Indications.....	128
8.11.4	Setting the node address	129
8.11.5	Field wiring.....	130
8.12	Cable Terminations and Routing	137
9	Maintenance.....	141
10	Specification	142
10.1	General.....	142
10.2	Graphical user interface	142
10.3	Dual 25Watt amplifier card	142
10.4	50Watt amplifier card	143
10.5	150Watt amplifier card	143
10.6	Multi-purpose output card.....	143
10.7	Multi-purpose interface card	144
10.8	Distribution CPU card.....	144
10.9	Quad radial EIS line card	145
10.10	Dual loop EIS line card.....	145
10.11	Network interface card	145
10.12	Universal rack frame	146
10.13	Power Supply.....	146
10.14	PAIC -HLI Bosch Praesensa	146
10.15	Remote Paging Console.....	147
11	Glossary Of Terms.....	148
	Definitions	149
12	System Concepts – Multi Zone system with SECP & RPCs	151
13	Distributed system. Cabling Scheme. Panels c/w controls OR Data Gathering Panel (DGP) option. 152	
14	Combined FDCIE and EWCIE system Example	153

Table of Figures

Figure 4-1 - Evacu ^{ELITE} and FireFinder ^{PLUS} 24U COMBO unit - external view	13
Figure 4-2 - All-purpose back plane board	15
Figure 4-3 Front view of the universal rack.....	15
Figure 4-4 Side view of the universal rack	16
Figure 4-5 Power supply module.....	16
Figure 4-6 Primary power supply labelling.....	17
Figure 4-7 Secondary power supply labelling.....	17
Figure 4-8 Power supply distribution board.....	18
Figure 4-9 Three power supply modules connected to the power supply distribution board	19
Figure 4-10 Power supply - showing the primary power supply module	19
Figure 4-11 Main GUI and LED membrane.....	21
Figure 4-12 Graphical user interface	22
Figure 4-13 Distribution CPU.....	23
Figure 4-14 Multi-purpose output card	24
Figure 4-15 Multi-purpose interface card	24
Figure 4-16 Dual 25-watt amplifier.....	25
Figure 4-17 50-watt amplifier.....	25
Figure 4-18 150-way amplifier	26
Figure 4-19 Quad radial EIS line card (ILC)	27
Figure 4-20 Dual loop EIS line card	27
Figure 4-21 Network interface card.....	29
Figure 4-22 Detail on fitting the SFP module to the NIC for VDSL Connection (2 core copper)	30
Figure 4-23 Detail of PAIC Layout	31
Figure 4-24 Detail of DCPU Card with Audio Jack fitted	32
Figure 5-1 Front Control Panel	34
Figure 5-2 Front control panel with individual EWS controls and indicators highlighted	39
Figure 5-3 Emergency zone with indicators highlighted.....	39
Figure 5-4 Emergency zone with controls highlighted	39
Figure 5-5 Front control panel with the individual EIS controls and indicators highlighted.....	41
Figure 5-6 WIP handset with controls highlighted	41
Figure 5-7 WIP handset with indicators highlighted	41
Figure 5-8 LED Indicators	43
Figure 6-1 Main menu screen.....	55
Figure 6-2 Access level screen.....	56
Figure 6-3 Distribution CPU card status screen.....	59
Figure 6-4 Distribution CPU card status	59
Figure 6-5 Input status	60
Figure 6-6 Distribution CPU card status - showing the outputs	60
Figure 6-7 Network interface card status screen	61
Figure 6-8 Network interface card status	61
Figure 6-9 Multi-purpose interface card status screen	62
Figure 6-10 Multi-purpose interface card status.....	62
Figure 6-11 Multi-purpose interface card showing the outputs	63
Figure 6-12 Multi-purpose output card status screen	64
Figure 6-13 Multi-purpose output card status	65
Figure 6-14 Output status	65

Figure 6-15 Quad radial EIS line card status screen..... 65

Figure 6-16 Quad radial EIS line card status..... 66

Figure 6-17 Handset status 66

Figure 6-18 Quad radial EIS card status showing the inputs..... 66

Figure 6-19 Dual loop EIS line card status screen..... 67

Figure 6-20 Dual loop EIS line card status..... 67

Figure 6-21 Handset status 68

Figure 6-22 Dual loop EIS line card input status screen..... 68

Figure 6-23 Dual loop EIS line card output status screen 69

Figure 6-24 Dual 25-watt amplifier card status screen..... 70

Figure 6-25 Dual 25-watt amplifier card status..... 70

Figure 6-26 Amplifier status 71

Figure 6-27 50-watt amplifier card status screen..... 71

Figure 6-28 PAIC status screen 72

Figure 6-29 PAIC status screen 72

Figure 7-1 24U Cabinet – Front and side view 92

Figure 7-2 24U Cabinet - Rear view showing mounting points..... 93

Figure 7-3 24U Cabinet – Top view showing the gland plate and cable entry..... 93

Figure 7-4 13U Cabinet - Front and side view 94

Figure 7-5 13U Cabinet - Rear view showing mounting points..... 94

Figure 7-6 13U Cabinet - Top view showing gland plate and cable entry..... 95

Figure 7-7 13U Cabinet showing the mains isolator, earth point and battery isolator 95

Figure 7-8 24U Cabinet showing the mains isolator, earth point and battery isolator 96

Figure 8-1 Label 3203 detailing terminations for each card type..... 98

Figure 8-2 MOC wiring – Standard Single End VAD Output 104

Figure 8-3 MOC wiring - Voltage Reversal Method (Used for Dual Strobe or Dual VAD options) 105

Figure 8-4 Dual 25Watt amplifier wiring..... 111

Figure 8-5 50Watt amplifier wiring..... 114

Figure 8-6 150Watt amplifier wiring..... 116

Figure 8-7 Quad radial EIS wiring 119

Figure 8-8 Dual loop EIS wiring..... 122

Figure 8-9 Network wiring - side by side cabinets..... 130

Figure 8-10 Network wiring - 2 core copper 131

Figure 8-11 Network wiring – Single mode, single fibre 132

Figure 8-12 Network wiring - Single mode, dual fibre 133

Figure 8-13 Network wiring - Multi mode dual fibre..... 134

Figure 8-14 Network wiring – Mixed - Fibre 135

Figure 8-15 Networking wiring – Mixed - VDSL..... 136

Figure 8-16 Correct speaker wiring termination 137

Figure 8-17 Incorrect speaker wiring termination..... 138

Figure 8-18 Cable routing - left hand side..... 139

Figure 8-19 Cable routing - right hand side..... 140

1 Certification Information

EVACU ELITE EMERGENCY WARNING AND INTERCOMMUNICATION SYSTEM

MANUFACTURED BY:

AMPAC Pty Ltd.

7 LEDGAR RD
BALCATT
WA 6017
WESTERN AUSTRALIA
PH: 61-8-9201 6100
FAX: 61-8-9201 6101
www.ampac.net



CONFORMS TO: AS 4428.16

AS 4428.4

AS 7240.4

ACTIVFIRE CERTIFICATE OF COMPLIANCE NUMBER: afp-3761

LPCB Certificate No: 966d

2 Purpose

This manual is a user guide to the Ampac EvacU^{ELITE}, to assist personnel in the installation, commissioning and operation of the EvacU^{ELITE}.

2.1 Scope

The information within this manual is only available to and for the use of personnel engaged in the installation, commissioning and operation of the EvacU^{ELITE}.

It is assumed the user of this manual is familiar with the operation of EWCIE and EICIE as required by the relevant product standards (AS 4428.4 and AS 4428.16).

The terminology used in this manual is consistent with the terminology used in the product standards.

2.2 References

2.2.1 EvacU ELITE System Manuals:

- MAN3137 EvacU^{ELITE} Install, Commissioning and User Manual
- COS010 EvacU^{ELITE} Consultant Specification
- MAN3142 EvacU^{ELITE} Programming Manual
- MAN3168 EvacU^{ELITE} Emergency Operating Instructions
- MAN3169 EvacU^{ELITE} EvacUWiz Plus - Config Function FAQs

Manuals have version number suffix. Eg Man3137-4 indicates version 4.

2.2.2 Compliance Standards -Australian

AS 4428.4	Fire Detection, Warning, Control and Intercom Systems – Control and indicating Equipment. Part 4: Emergency intercom control and indicating equipment.
AS 4428.16	Fire Detection, Warning, Control and Intercom Systems – Control and indicating Equipment Part 16: Emergency warning control and indicating equipment.
AS 7240.4	Fire detection and alarm systems Part 4 Power supply equipment
AS 1670.4	Fire Detection, Warning, Control and Intercom Systems – System Design, Installation and Commissioning. Part 4: Emergency warning and intercom systems

To comply with AS 7240.4, the EvacU ELITE power supply equipment has been assessed to AS/NZS 60950.1 – Information technology equipment – Safety, Part 1 General requirements.

The EvacU ELITE also complies with IEC 62368-1 Audio / video, information and communication technology equipment – Part 1 Safety requirements.

IEC 62368 has replaced IEC 60950 as the safety standard in some overseas countries, and as EvacU ELITE will be sold overseas, approval to both safety standards is required.

Refer to section 7.8 for guidelines on selecting batteries to adhere to the IEC 62368 requirements.

3 System overview

3.1 General

The Evacu^{ELITE} has been designed to meet the requirements of an Emergency Warning Control and Indicating Equipment (EWCIE) and Emergency Intercom Control and Indicating Equipment (EICIE), conforming to AS 4428.16 and AS 4428.4. The power supply component of the Evacu^{ELITE} conforms to AS 7240.4

Certificates of Conformity from Activefire are available which verify conformance to AS 4428.4, AS 4428.16 (Grade 1) and AS 7240.4

The EWCIE and EICIE functionality are integrated on the Evacu^{ELITE}.

The EWCIE is the central component of an Emergency Warning System (EWS). Other components that make up an EWS are:

- Manual call points (MCPs)
- Loudspeakers
- Visual Alarm Devices (VADs)
- Warning equipment for people with hearing impairment
- Transmission path isolators (TPIs) – if fitted.

The EICIE is the central component of an Emergency Intercom System (EIS). Other components that make up an EIS are:

- Warden Intercom point (WIP) handsets
- Transmission path isolators (TPIs) – if fitted

Emergency Warning and Intercom System (EWIS), is a system where the Emergency Warning has been integrated with the Emergency Intercom.

The Evacu^{ELITE} is capable of being designed to function stand-alone, networked or a distributed configuration.

3.2 Access levels

The product standards AS 4428.4 and AS 4428.16 define access levels for the indications and controls relating to mandatory functions. Section 5 details the controls and indicators and specifies the required access level for each control.

There are four access levels.

Access level 1 – is used by persons having a general responsibility for safety supervision. All mandatory indications are visible at access level 1 – without prior manual intervention. This is achieved by viewing the indicator via the Perspex sheet fitted to the outer door of the cabinet. Refer to figure 4-1.

Access level 2 – is used by persons having a specific responsibility for safety and who are competent and authorised to operate the Evacu^{ELITE} in the quiescent condition, emergency warning condition, fault warning condition, disabled condition and test condition. Entry to access level 2 is achieved by opening the outer door by unlocking the 003 keyed door locks.

Access level 3 – is used by persons who are competent and authorised to re-configure the site-specific data held within the Evacu^{ELITE} or controlled by it and maintain the Evacu^{ELITE} in accordance with manufacturer's published instructions. Eg Tasks such as Labelling, Zoning, Alarm organisation, stored speech messages and tones.

Entry to access level 3 is achieved by entering a User ID and Password on the Touchscreen keypad.

Some facilities – for example setting the date and time and sequence choices, require access level 3. If the EvacU^{ELITE} outer door is open and a command/facility requiring access level 3 is attempted, the EvacU^{ELITE} will prompt a level 3 User ID and password. Refer to section 6.2.

Access Level 4 – is used by persons who are competent and authorized by the manufacturer either to repair the EWCIE or alter its firmware, thereby changing its basic mode of operation.

3.3 Emergency warning control and indicating equipment.

The product standard for EWCIE (AS 4428.16) details three grades of equipment.

The following table details the mandatory, optional and excluded functionality for each grade.

The EvacU^{ELITE} conforms to Grade 1.

Clause number	Title	Grade 1	Grade 2	Grade 3
7.2	Indication of alarm signals	M	M	O
7.3	Alert signal (also used for non-fire emergency)	M	O	O
7.5	Indication of the emergency warning condition	M	M	M
7.6	Audible indication of alarm signal reception	M	M	O
7.7	Delay before emergency warning condition	O	X	X
7.8	Phased evacuation for multi-zoned systems	M	M	X
7.9.1	Silencing the emergency warning condition from the emergency detection system	X	O	O
7.9.2	Silencing the emergency warning condition with a manual control	M	O	O
7.10.1	Reset of the emergency warning condition from the emergency detection system	X	O	O
7.10.2	Reset of the emergency warning condition with a manual control	M	O	O
7.11	Output to warning devices	M	M	O
7.12	Emergency warning condition output signal	M	O	O
8.3.4	Faults related to emergency zones	M	M	M
8.3.5	Earth fault	M	M	M
8.4	System fault	M	M	M
9	Disabled condition	M	O	O
10	Test condition	M	M	O
11	Automatic/manual mode control	M	O	O
11.2	Manual control of distributed EWCIE	M	O	O
12.1	Individual emergency zone controls	M	O	O
12.2.2	All alert control	M	O	O
12.2.3	All live speech	M	O	O
12.2.4	All evacuate control	M	M	O
12.4	Indication of emergency zones in the fault warning condition	M	M	O
13	Interface to external device(s)	O	O	O
14	Emergency microphone	M	M	O
14.2	Ready-to-talk indicator	M	O	O
15.15	Redundant power amplifiers	O	O	O

LEGEND:

M = mandatory function

O = optional function

X = shall not be provided

<input type="radio"/>	Option Included in the EvacU ^{ELITE}
<input type="radio"/>	Option not included in the EvacU ^{ELITE}

3.4 Emergency intercom control and indicating equipment.

The following optional clauses of AS 4428.4 are supported by the EvacU^{Elite}.

Clause 8.8 External silencing of the EICIE Fault Condition

Clause 9.0 Zone Cleared Condition

Clause 10.0 Manual Control of Networked EICIE

Clause 11.2 WIP group call control – up to 6 handsets, including the EICIE handset.

4 System Description

4.1 General

The EvacU^{ELITE} is a modular EWIS that consists of a number of cards supported in one or more universal rack frames, with a scalable power supply and graphical user interface, housed in a metal cabinet. The cabinet is available in two cabinet sizes: 13U and 24U.

Both cabinets can accommodate a FireFinder^{PLUS} in the top section when a COMBO solution is required.

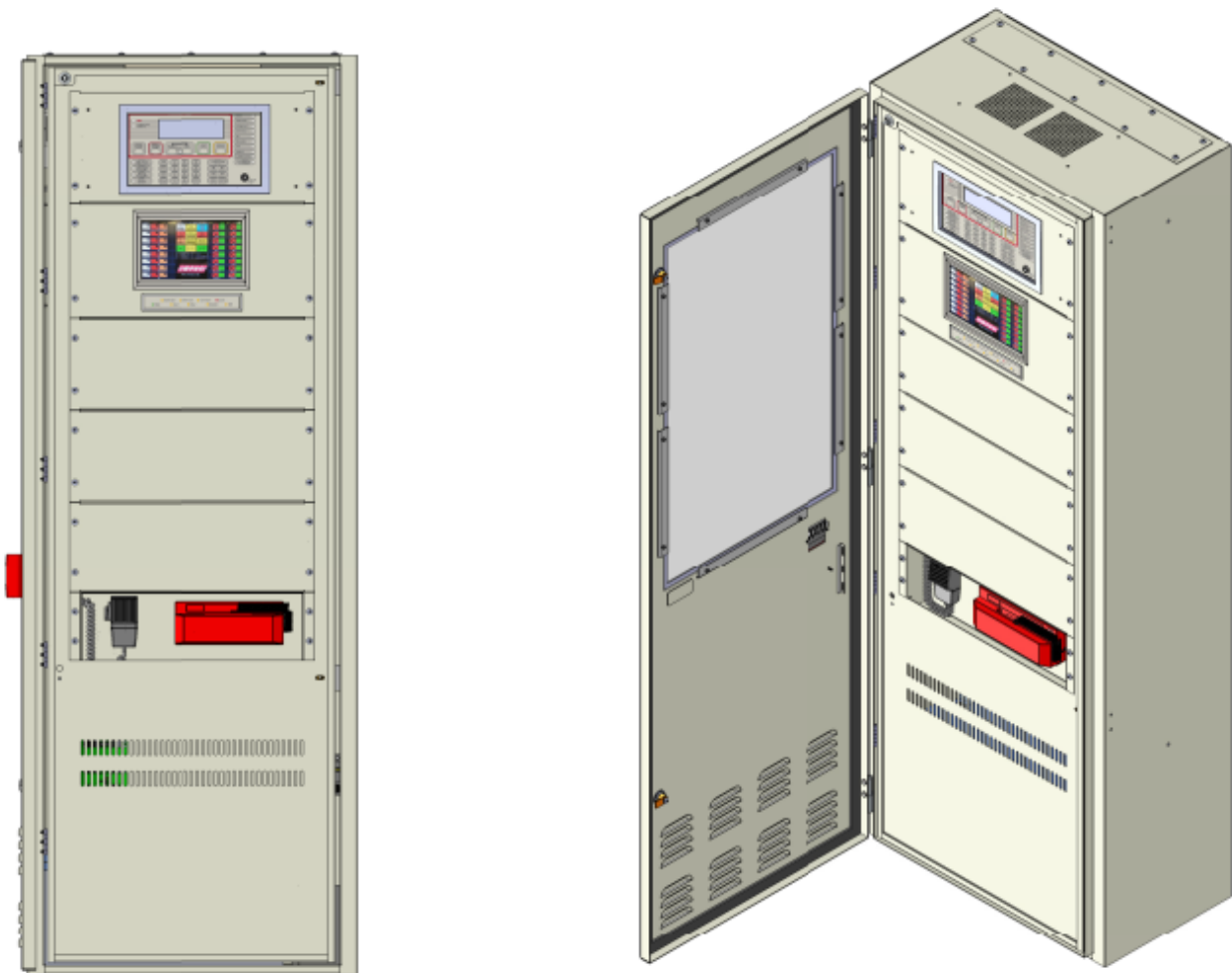

Figure 4-1 - EvacU^{ELITE} and FireFinder^{PLUS} 24U COMBO unit - external view

Figure 4-1 above shows an external view of the EvacU ELITE and FireFinder PLUS. The cabinet size is 24U. Cabinet has been designed so all controls are 750mm from floor level.

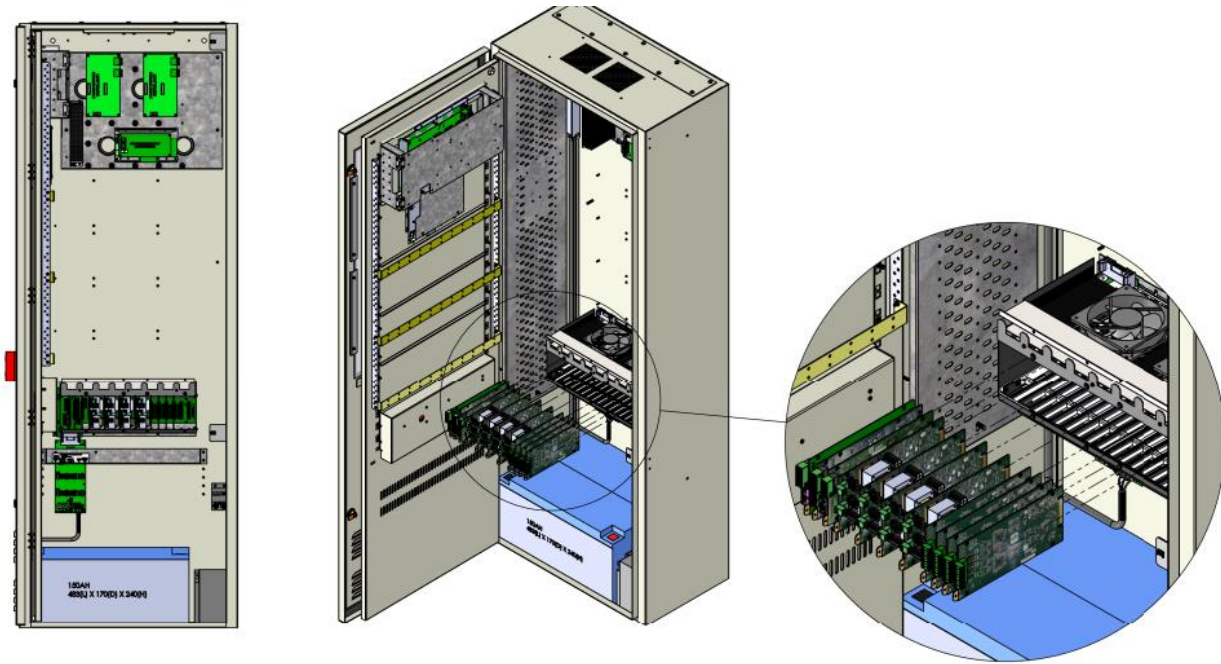

Figure 4-2 Evacu ^{ELITE} and FireFinder ^{PLUS} COMBO unit internal view

Figure 4-2 shows the internal view of the Evacu ^{ELITE} and FireFinder ^{PLUS}. The cabinet size is 24U. This configuration shows a single universal rack frame with a number of cards fitted, scalable power supply and single graphical user interface fitted.

4.2 System Components

4.2.1 Universal Rack

Universal rack holds the various cards. Card types are:

Board ID	Kit Code	Abbreviation	Description
BRD63CPUx-A	6350-DCPU	DCPU	Distribution CPU (Mandatory for each rack)
BRD63CPUx-B	6350-DCPU-B	DCPU-B	Special Build DCPU board used with PAIC (Bosch Praesensa interface)
BRD63NICx-A	6350-NIC	NIC	Network interface card (attached to the DCPU in the first rack only)
BRD63MOCx-A	6350-MOC	MOC	Multi-purpose output card
BRD63MICx-A	6350-MIC	MIC	Multi-purpose interface card
BRD63LPAx-A	6350-LPA25W-DUAL	LPA	Dual 25W amplifier
BRD63LPAx-B	6350-LPA50W	LPA	50W amplifier
BRD63HPAx-B	6350-HPA150W	HPA	150W amplifier
BRD63ILCx-A	6350-ILC	ILC	Quad radial EIS line card
BRD3LILC	6350-LILC	LILC	Dual loop EIS line card
BRD63NICxB	6350-PAIC	PAIC	Public Address Interface Card - HLI Bosch Praesensa
BRD63AICx-A	6350-AIC	ALIC	Audio Line Interface Card (Future Release)
BRD63GUIx-C	6310-RPC	RPC	Remote Paging Console (GUI) (Future Release)

The number and type of cards fitted to a rack depends on the site configuration.

The 24U cabinet can accommodate 5 universal racks and the 13U cabinet can accommodate 2 universal racks.

The rack is fitted with an all-purpose backplane. The back plane of the rack performs the following:

- Delivery of power to each card
- Communications between the DCPU and each slot for the transfer of control information and the streaming of audio.

Each rack has a dedicated DCPU slot (slot 0) and 16 slots for cards. The LPA and HPA each require 2 slots. The NIC when fitted occupies 1 slot adjacent to the DCPU.

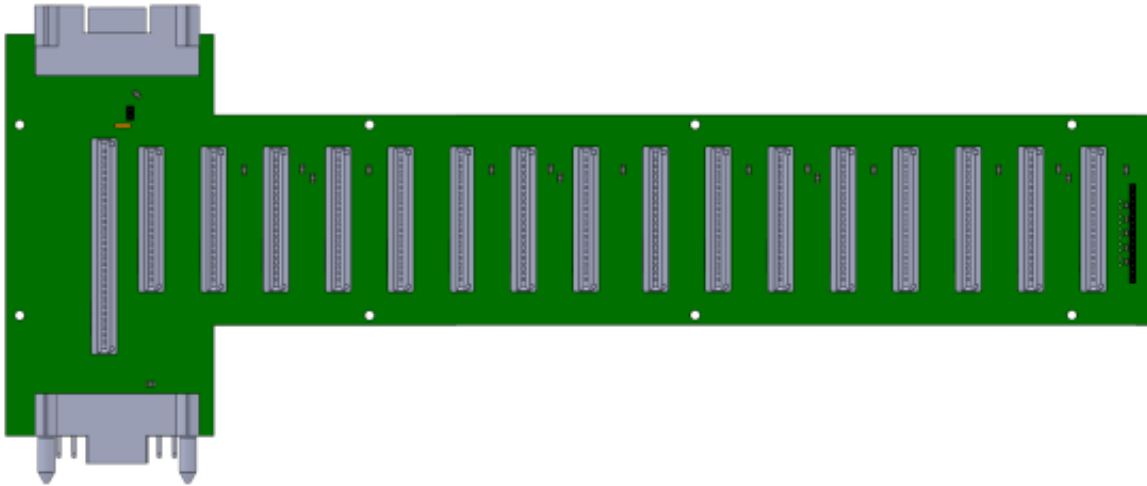

Figure 4-2 - All-purpose back plane board

Figure 4-2 shows the all-purpose back-plane with the dedicated DCPU connector on the left, and 16 card connectors.

The vertical connectors on the left-hand side are used to connect all-purpose backplanes together.

The first rack (lowest position in the cabinet) connects to the power distribution board – refer to section 4.2.2

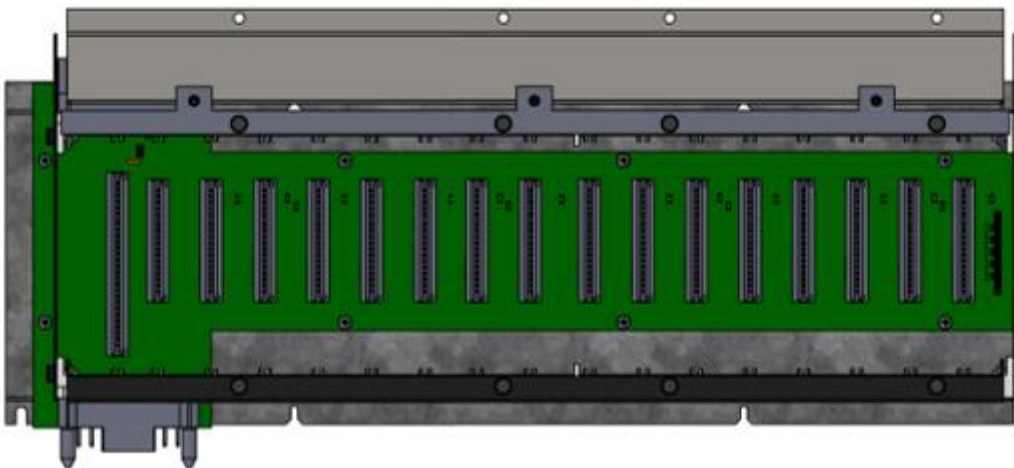

Figure 4-3 Front view of the universal rack

Figure 4-3 shows a front view of the universal rack with the all-purpose backplane fitted. The top section of the rack is a cabling duct.

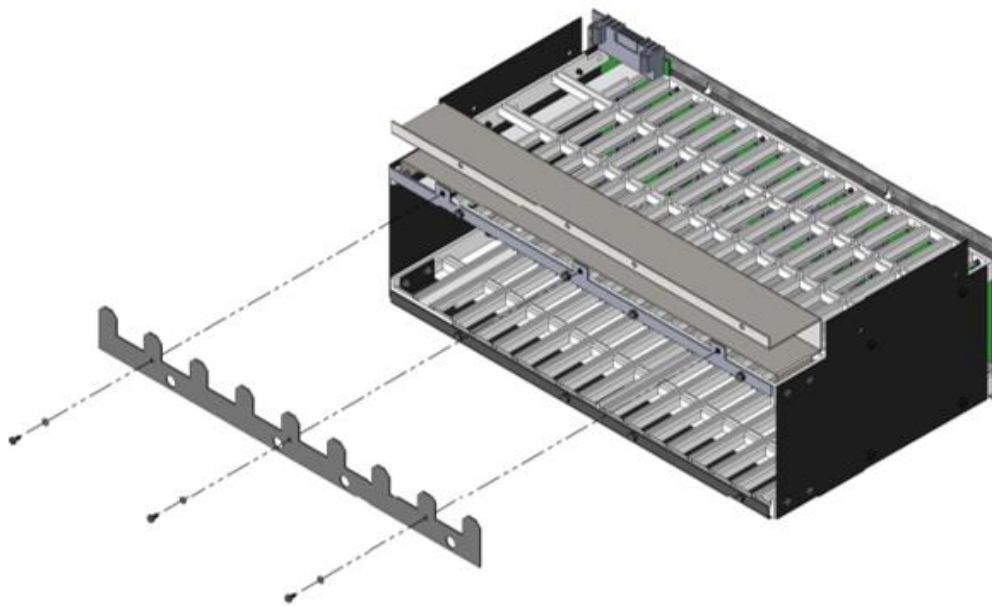

Figure 4-4 Side view of the universal rack

Figure 4-4 shows the side view of the universal rack with the all-purpose backplane fitted. The side view shows the cabling ducting located on top of the rack and the retaining plate for the cards (fitted to the rack).

A fan tray can be fitted to the top of the universal rack (behind the cable ducting) for air circulation.

4.2.2 Power Supply

4.2.2.1 General

Power supply consists of up to three power supply modules (the 13U cabinet can accommodate 2 power supply modules). The first module which is always fitted is referred to as the primary and controls the charging of the batteries, and the second and third modules are secondary units which are fitted depending on the alarm current required for the cabinet (depends on the site-specific data)

Each power supply module consists of an off the shelf Meanwell power supply and an Ampac designed power control card.



Figure 4-5 Power supply module

4.2.2.2 PSU Labelling

Following labelling is used on the primary power supply module.

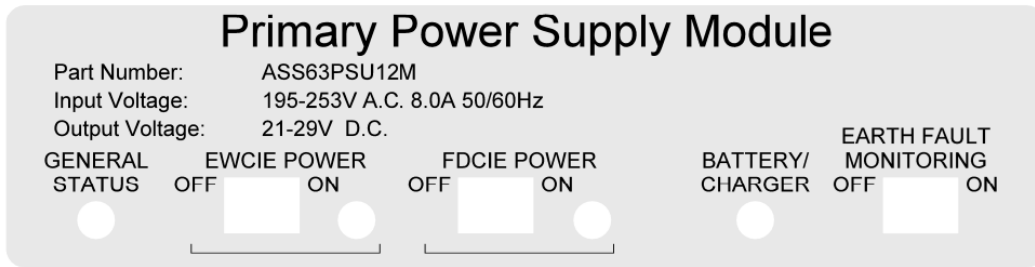

Figure 4-6 Primary power supply labelling

General Status

LED Indication	Condition
Off	No power
Green steady	Normal – mains available
Green flashing	Mains is off – running from the standby power source
Yellow flashing	Fault – for example blown fuse, incorrect checksum, PSU fault, bus fault, charger damage

EWCIE Power – controls the power to the Evacu^{ELITE}. When power is available the Indicator will be lit Green steady. If the EWCIE LED is flashing Yellow. **Turn off** the EWCIE power switch. If it fails to isolate power to the racks the primary power supply module will require replacement. Swarf or foreign objects entering a PSU may cause it to flash yellow in which case remove any foreign debris.

FDCIE Power – controls the power to the FireFinder^{PLUS}. Indicator is lit when power is available ***See Section 14** showing connection detail between EWCIE PSU module and FDCIE for Combo systems.

Battery / Charger

LED Indication	Condition
Off	On batteries or no power
Green steady	Battery is charged (greater than 80%)
Green flashing	Battery is charging
Yellow flashing	If mains on – charger has failed. If mains off, battery has failed (voltage < disconnect voltage)
Yellow fast flash	Battery is reversed
Yellow steady	Battery is isolated or missing and mains is on

Earth fault monitoring – enables/disables the earth fault monitoring.

Following labelling is used on the secondary power supply module.



Figure 4-7 Secondary power supply labelling

General Status

LED Indication	Condition
Off	No power
Green steady	Normal – mains available
Green flashing	Mains is off – running from the standby power source
Yellow flashing	Fault – for example blown fuse, incorrect checksum, PSU fault, bus fault, charger damage

EWCIE Power – indicator lit when power is available to the EWCIE (note comment above about flashing yellow EWCIE power Led on Primary PSU module)

4.2.2.3 Power Distribution Board

The power distribution board routes the power from the power supply modules to the cards mounted in the universal racks and provides termination for the main power source and standby power source.

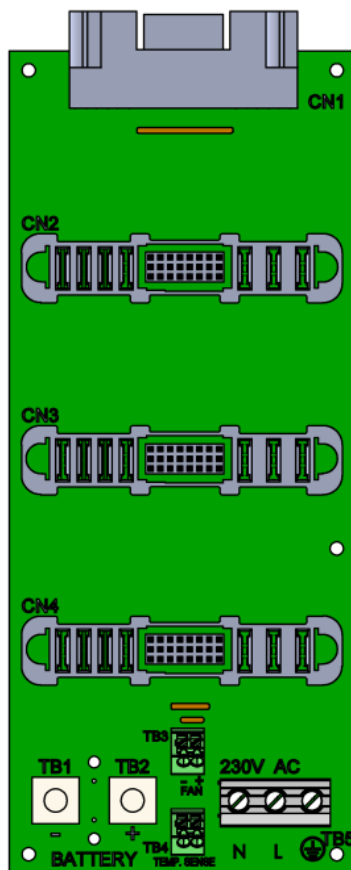

Figure 4-8 Power supply distribution board

The Power distribution board has termination for the primary power source (mains) and the standby power source (batteries).

CN1 connects to the first all-purpose backplane. CN2 connects to the primary power supply module, and CN3 and CN4 connect to the secondary power supply modules.

TB1 and 2 connect to the standby power source (batteries)

TB3 is the connection to the air circulating fans.

TB4 is the connection to a temperature sensor sited adjacent to the batteries (temperature of the batteries is required, so the batteries can be charged to the manufacturer’s specification)

TB5 is the connection to the main power source (mains)

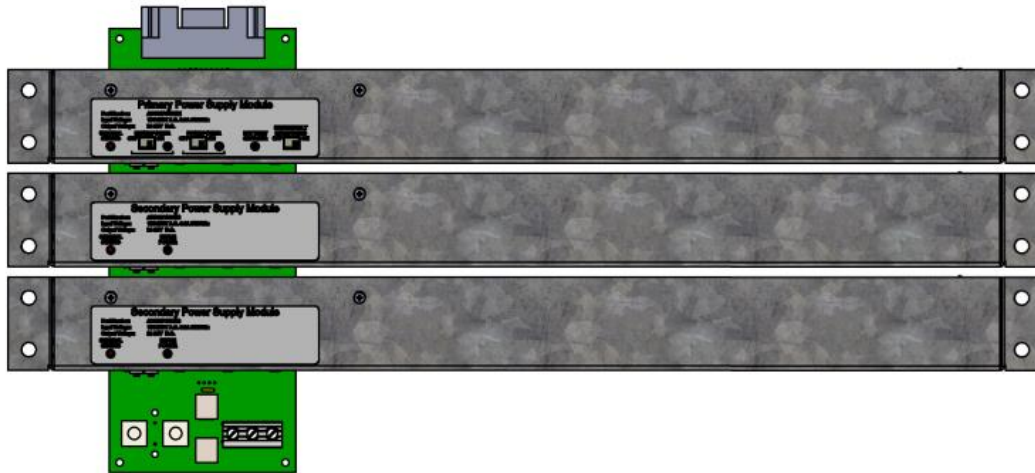

Figure 4-9 Three power supply modules connected to the power supply distribution board.



Figure 4-10 Power supply - showing the primary power supply module.

Fig 4-10 shows the power supply and universal rack with cards fitted.

The primary and standby power source wiring is visible.

The wiring for the air circulating fans and battery temperature sensor is visible.

4.2.3 Combo Systems - Power distribution

When a combined Fire Finder Plus & EvacUElite system is installed as a combo a CPI board is fitted. The **FireFinder Plus** manual explains how the CPI board should be configured.

A connection is made between the EvacUElite Primary PSU 'PCC board" which provides 27v dc power to the FireFinder Plus Brigade board. RJ45 cables interconnect the FireFinder Plus Main connection board to the Brigade board then links to the (CAN Power Supply interface card **CPI**) which also links to the EvacUElite MIC HLI RJ45 connection. This provides the internal comms links integrating the two systems.

The **CPI** card fits onto the Power supply distribution board bus as illustrated below. **See section 14.**

Refer to following when configuring this board.

MAN3142 EvacUElite Programming Manual

MAN3016 FireFinder Plus Programming Manual

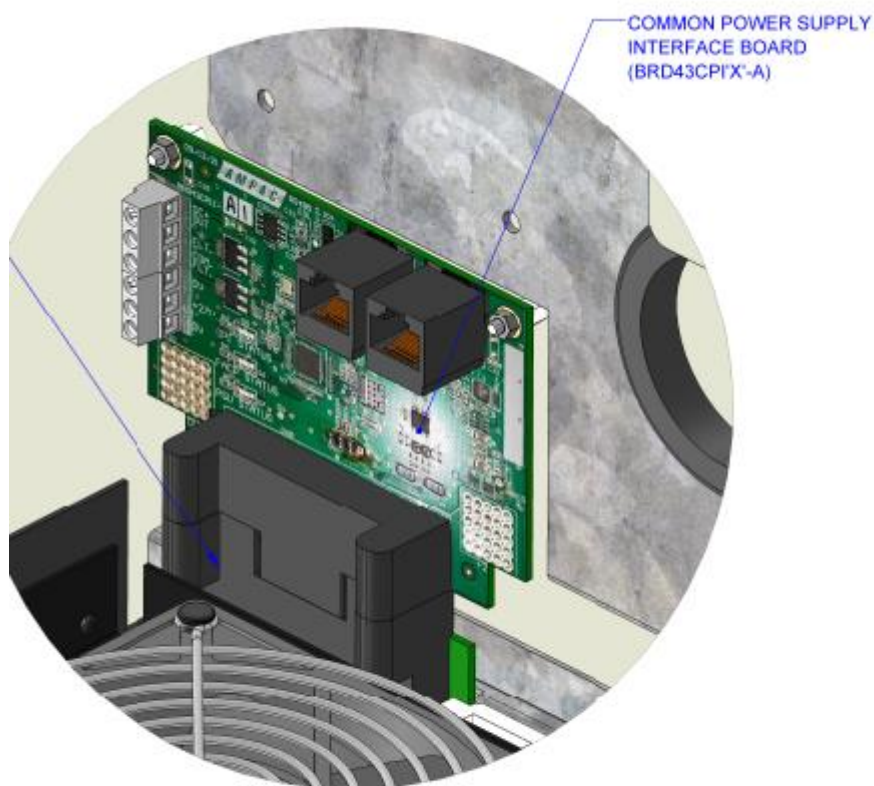

4.2.4 Graphical User Interface

The GUI provides the user interface via one or more colour touch screens and a LED membrane.



Figure 4-11 Main GUI and LED membrane

The Main GUI has the system wide controls, and individual controls for emergency zones and WIP handsets – according to the site-specific data.

Where more individual controls are required, additional **Secondary GUIs** are added. The 13U cabinet supports 4 GUIs and the 24U cabinet supports 8 GUIs. This is based on the Perspex **window space available**.

When more EWS and EIS zone capacity is required, extra cabinets are placed side by side to expand the user control requirements. One node will support a maximum capacity of 20 GUI screens. To expand further additional panel nodes can be networked to deliver the largest system solutions.

The LED membrane has dedicated indicators for system wide conditions.

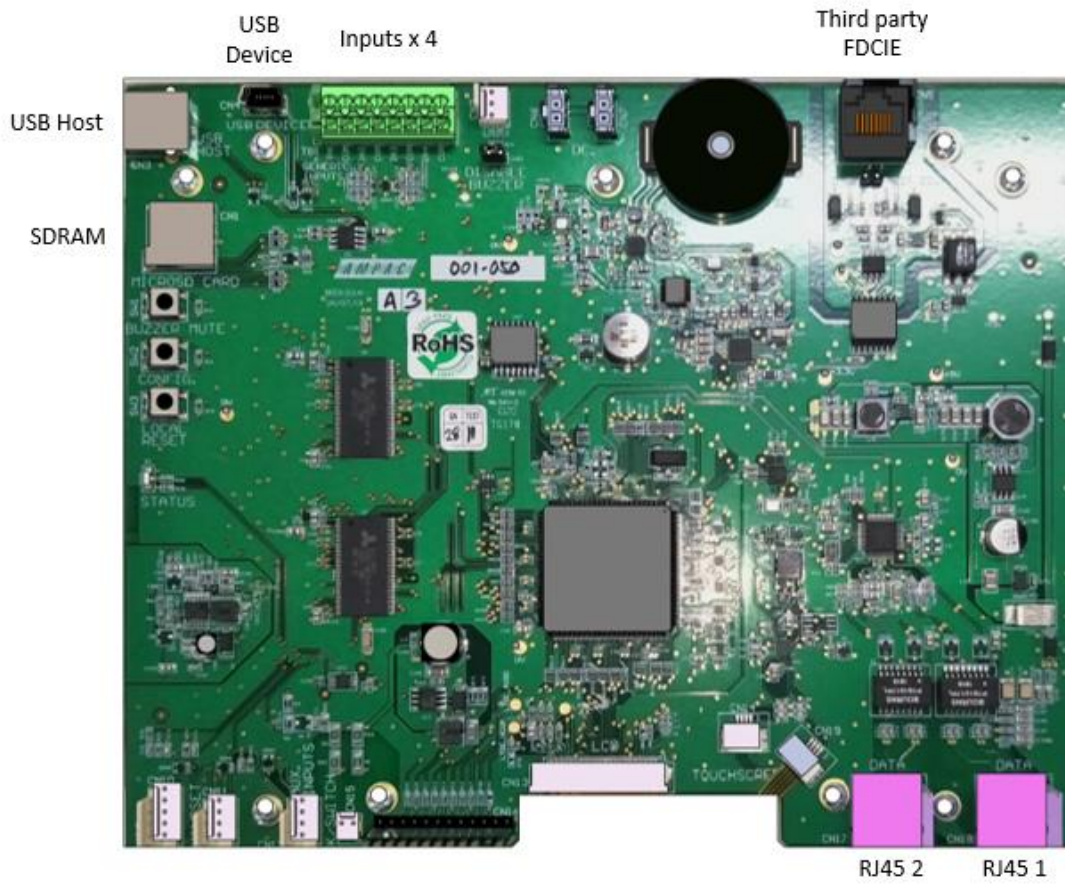

Figure 4-12 Graphical user interface

The touchscreen is a 9-inch TFT LCD 800 x 480 with LED backlighting and resistive touch screen.

USB Host	Used to update firmware and configuration files by USB Flash drive
USB Device	Connection to the PC Programming App
SDRAM	SDRAM card socket
Inputs x 4	<p>The GUI inputs should Not be used to connect to External sources outside of EvacUElite (Use MIC) for such applications</p> <ul style="list-style-type: none"> Inputs 1 & 2 are monitored c/w EOL selection and Action type available Inputs 3 & 4 are Not monitored (Action type available) <p>When fitted: Input 1 is dedicated to the front panel MCP Input 4 is dedicated to the door switch.</p>
Third party FDCIE	Isolated RS 485 link to interface to third party FDCIE / Graphics interface
RJ45 1	Connection to Distribution CPU
RJ45 2	Connection to Slave GUI

4.2.5 Universal Rack Cards

The following are the universal rack cards.

4.2.5.1 Distribution CPU

Each rack has a dedicated slot for a DCPU.

The DCPU has the link to the GUIs and controls the cards in the rack frames by issuing commands and routing the required audio down the rack all-purpose back plane.

The DCPU fitted to rack 1 (closest to the power supply) is the main DCPU for the cabinet.



Figure 4-13 Distribution CPU

The distribution CPU provides the following connections:

Audio 1 & 2	Analog line level audio input (hot, cold and shield), 10k Ω impedance, max input +4dBu
Input 1 & 2	Supervised input, selectable EOL, common reference.
Relay 1	Double pole, single throw (1 x NO, 1 x NC, 2 x COM)
Relay 2 & 3	Single pole, double throw (COM, NO, NC)
Mini USB	For future use
RJ45 1	Provides a CAT5/6 network connection to the front panel GUI
RJ45 2	Redundant CAT 5/6 ethernet connection to the front panel GUI / Remote paging consoles

4.2.5.2 Multi-purpose output card

Occupies one slot.

Provides eight single ended supervised outputs, suitable for driving alarm warning devices such as strobes (VADs) or vibrating pads.

Each pair of outputs can be configured as a reverse polarity output, suitable for driving Ampac alert/evac strobes. Refer to section 8.3 for suitable alert and evac strobes.



Figure 4-14 Multi-purpose output card

Outputs 1, 2, 3, 4, 5, 6, 7 and 8	Single ended supervised output/ paired output (voltage reversal), max 2 amps per output and 6 amps per card. Selectable EOL. Output voltage range 12 to 28VDC.
--------------------------------------	--

4.2.5.3 Multi-purpose interface card

Occupies one slot.

Provides eight supervised inputs, two relay outputs and a high-level interface to the Ampac FireFinder ^{PLUS} Add On Bus.



Figure 4-15 Multi-purpose interface card

Input 1, 2, 3 and 4	Single ended inputs, common floating reference with selectable EOL
Input 5, 6 and 7	Differential inputs, individual floating reference with selectable EOL
Input 8	Differential input, with floating reference with fault feedback (user selectable resistance)
Relay 1 and 2	Single pole, double throw (COM, NO, NC)
Serial	RS232C serial port, with CTS and RTS available. Currently unused
FACP	Add On bus connection to the Ampac FireFinder ^{PLUS}

4.2.5.4 Dual 25Watt Amplifier Card

Occupies two slots.

Class D amplifier with 2 x 25-watt independent audio outputs with DC monitoring



Figure 4-16 Dual 25-watt amplifier

Max Drive Voltage	100V rms @ full load
Distortion	<=0.1%@ 25Watt x2
Frequency Response (AS 4428.16)	400 Hz to 10kHz +/- 1dB w.r.t. 1kHz 200 Hz to 12kHz +/- 3dB w.r.t. 1kHz
SNR	>=70db
Speaker Circuit Monitoring	DC, nominal 47kΩ

4.2.5.5 50Watt Amplifier Card

Occupies two slots.

Provides one 50watt audio output with DC monitoring.



Figure 4-17 50-watt amplifier

Max Drive Voltage	100V rms @ full load
Distortion	<=0.1%@ 50 Watt
Frequency Response (AS 4428.16)	400 Hz to 10kHz +/- 1dB w.r.t. 1kHz 200 Hz to 12kHz +/- 3dB w.r.t. 1kHz

SNR	>=70db
Speaker Circuit Monitoring	DC, nominal 47kΩ

4.2.5.6 150Watt Amplifier Card

Occupies two slots.

Provides one 150watt amplifier with an integrated 4way audio splitter. Each audio output is individually switchable and DC supervised with a nominal 47kΩ.

Audio output #1 is rated at 150watt, and the remaining audio outputs (2, 3 and 4) are rated at 75watt max each.

One BGM Source input can be configured per 150-Watt amplifier.

8 modules can be fitted and configured into each Universal Rack

Maximum 20 per node (assuming no other modules fitted)

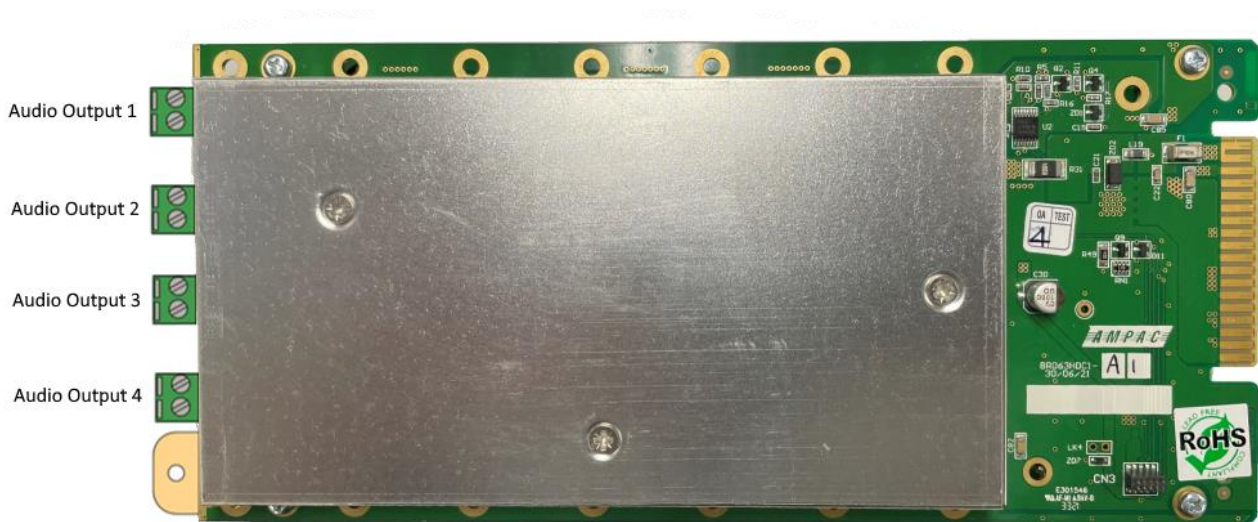

Figure 4-18 150-way amplifier

Max Drive Voltage	100V rms @ full load
Distortion	<=0.3%@ 150Watt x1
Frequency Response (AS 4428.16)	300 Hz to 10kHz +/- 1dB w.r.t. 1kHz 150 Hz to 12kHz +/- 3dB w.r.t. 1kHz
SNR	>=70db
Speaker Circuit Monitoring	DC, nominal 47kΩ

4.2.5.7 Quad Radial EIS line card aka (ILC) Intercommunication Line Card

Occupies one slot.

Provides 4 individually supervised interfaces to a handset and associated manual call point.



Figure 4-19 Quad radial EIS line card (ILC)

WIP handset 1, 2, 3 and 4	Inputs for Ampac EvacU ^{ELITE} WIP handsets (polarity insensitive). Up to 2 Ampac MCPs can be connected to each handset. Cabling size recommended is 1.5mm ² 2 Core, max length 1 km, line impedance 600Ω, bandwidth 3K4 Hz.
---------------------------	--

4.2.5.8 Dual Loop EIS line card aka (LILC) Loop Intercommunication Line Card

Occupies one slot.

Provides 2 individually supervised fault-tolerant loop interfaces for handsets and associated manual call points.

Each loop supports up to 20 handsets with associated manual call points.



Figure 4-20 Dual loop EIS line card

LOOP 1/2 IN/OUT	Inputs for Ampac EvacU ^{ELITE} Loop WIP handsets. Up to 2 Ampac MCPs can be connected to each handset. Max of 20 handsets per loop. Cabling size recommended 1.5mm ² 2 core UTP , max loop length 1000m. Note: Using Screened twisted instead of UTP on Loop WIPs reduces the loop distance capacity to 480M
-----------------	---

4.2.6 Networking

4.2.6.1 General

The EvacU^{ELITE} is capable of being arranged to function stand-alone, networked or a distributed configuration.

For a networked or distributed configuration, a Network Interface Card (NIC) is required at each node.

The NIC supports fault tolerant (loop topology) connectivity between cabinets.

There are 4 different physical communication links supported:

- RJ45 Ethernet connection – where cabinets **are <100m** – using CAT 5/6 UTP type cable. Typically used where two panel nodes stand side by side.
- 2 Core copper unshielded or shielded twisted pair with a minimum of 8-10 twists per meter suitable for distances up to 1000m using VDSL technology. Requires SFP OEM 3087 and OEM 3088 modules. Cat 5/6 can be used – only one pair utilised. This requires SFP OEM 3087 and OEM 3088 modules.
- When Using SFPs OEM 3087 and OEM 3088 a screened network cable is **reccomended in electrically noisy environments**.
- Multi-Mode Fibre optic – using dual fibre for distances up to 500m. Requires SFP OEM3097
- Single Mode Fibre optic – using single fibre (OEM3095 and OEM3096) or dual fibre (OEM3094) for distances up to 10,000m.

Side A	Side B	Description
OEM3087	OEM3088	VDSL – 2 core copper cable for distances up to 1000m
OEM3094	N/A	Single mode dual fibre – for distances up to 10000m See Note 1*
OEM3095	OEM3096	Single mode single fibre – for distances up to 10000m
OEM3097	N/A	Multi-mode dual fibre – for distances up to 500m See Note 1*

Note 1: * items not covered by LPCB certification at this point in time.

A network can be a mixture of the above physical communication links.

4.2.6.2 Network Interface Card

The NIC is connected to the DCPU to form a two-card stack. The NIC occupies slot 1 of the rack.

Address Dip Switch



Figure 4-21 Network interface card

Audio 1 & 2	Analog line level audio input (hot, cold and shield), 10kΩ impedance, max input +4dBu
SFP Transceiver 1 & 2	These are small form-factor pluggable (SFP) transceiver sockets
Ethernet 1 & 2	Ethernet RJ45 connectors

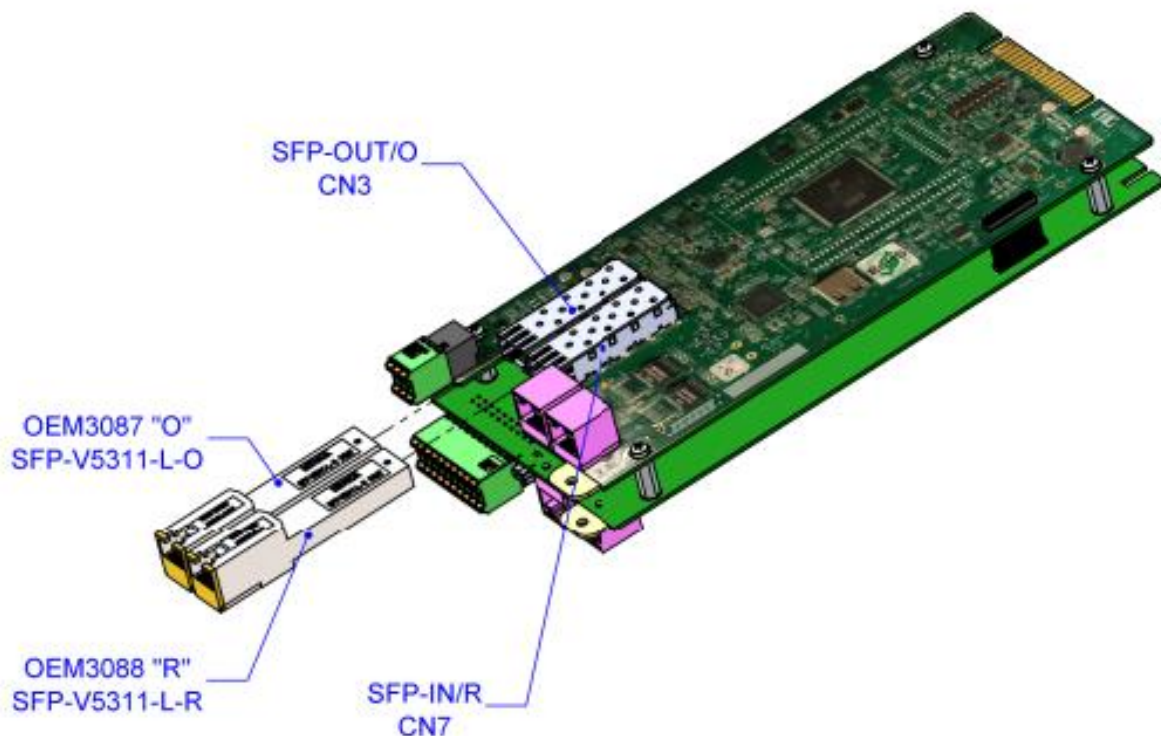

Figure 4-22 Detail on fitting the SFP module to the NIC for VDSL Connection (2 core copper)

To set the node address – refer to section 8.10.3

For networking wiring examples – refer to section 8.10.

4.2.7 Public Address Interface Card (PAIC)– Bosch Praesensa interface HLI

4.2.7.1 General information

- Please refer to Bosch CSIRO Application Note. **Interfacing Praesensa & Ampac EvacU Elite EWS Panel for AS4428 -16 Compliance** details the connections between both systems.
- PAIC is a High Level Interface module providing integration to PA systems.
- PAIC is configured using EvacUWiz Plus. Refer Section 6.14 MAN 3142
- PAIC -is fitted into the **Primary Universal Rack**.
- Ethernet cable connects between the **RJ45 Port** (purple connector) and the Bosch Praesensa PA system.
- More PAIC details can be found at Section 6.3.10. Section 8.10 and Section 10.14

The **Audio source** connection between EvacUElite and Bosch Praesensa system can originate from one of the following sources:

1. A DCPU Card (special build) which has an 'Audio out' Jack plug ***BRD63CPUx- B***
2. Ampac Audio Interface Card.

4.2.7.2 PAIC Interface Card

NIC VERSION B (BRD63NIC1-B)

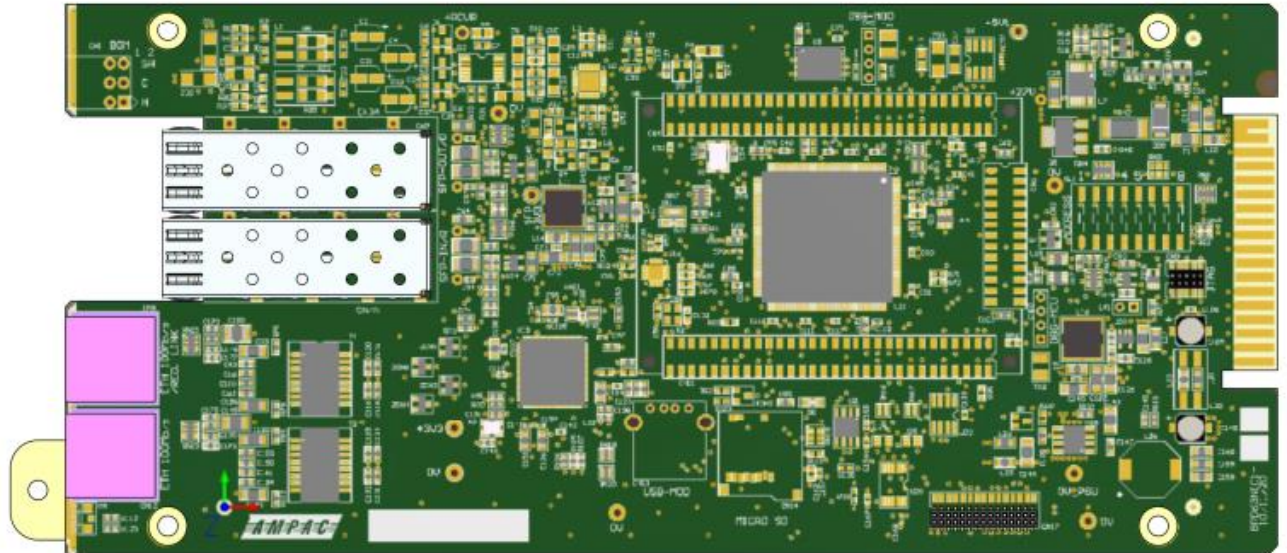

Figure 4-23 Detail of PAIC Layout



The PAIC Icon will feature in the **Node** screen layout when it is fitted into one of the Rack slots.

4.2.7.3 PAIC - DCPU Card requirements

A specific DCPU card version is used with PAIC (Kit Item No **6350-DCPU-B**)
Version B DCPU includes an Audio Jack output.

This audio output provides live speech from the EvacUElite emergency microphone(s) to the Bosch Praesensa PA system.

DCPU VERSION B (BRD63CPU1-B)



Figure 4-24 Detail of DCPU Card with Audio Jack fitted.

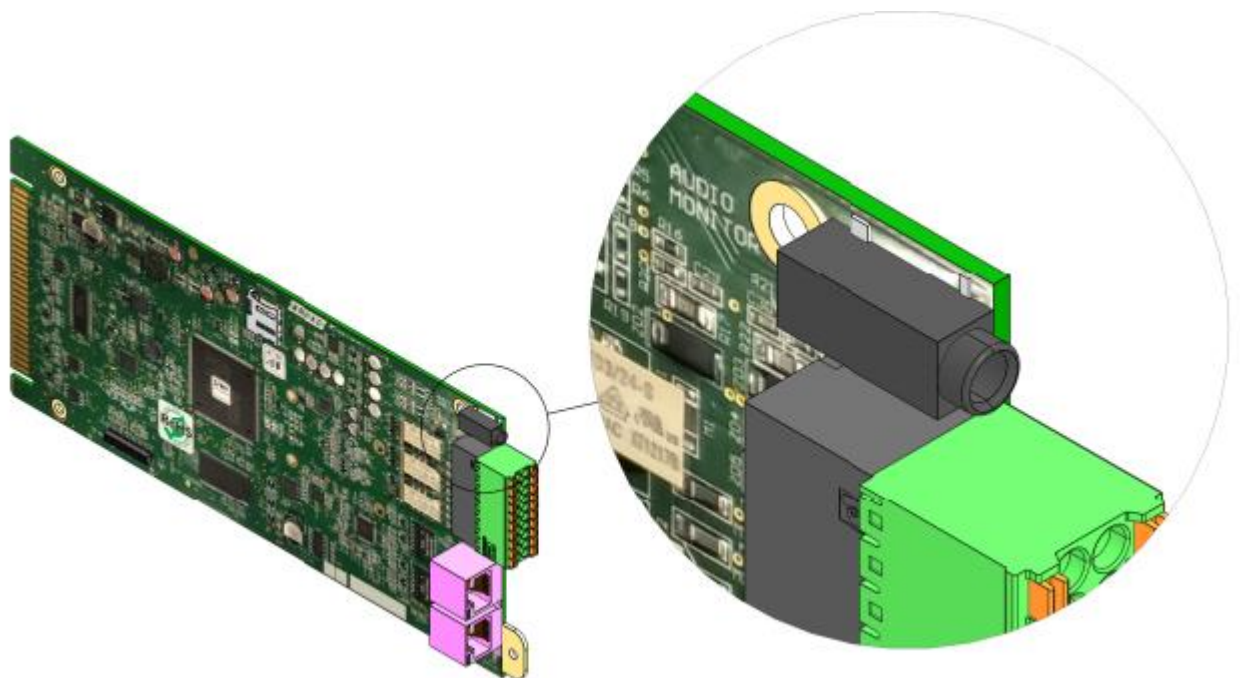

4.2.8 Remote Paging Console

The remote paging console unit (RPC) is a field connected Ancillary device configured to the EvacUElite system. The unit consists of a compact desk mounted '**GUI Touchscreen**' with a gooseneck microphone.

The RPC provides additional **Public address system features** utilising the Emergency Warning speaker system.

Each RPC can be configured to control specific **Paging Zones** and or **Paging Groups**

From the Ethernet port on **DCPU Rack 1 Up to 8 RPC units** can be interconnected (up to 100M apart) using Cat5/6 cable. The cabling requirements for multiple units involves a loop in loop out Cat 5/6 finishing at the final unit. **240v Power Packs** are supplied with each RPC. A local 240vAC power source is required to connect each RPC unit.

Paging features are treated as a **secondary priority** during Emergency Alarm events, so the paging functionality makes way for Emergency Microphone messages and building(s) Emergency tones.

See Programming Manual 3142 Section 6.17 for configuration details.



Cabling	From DCPU Cat5/6 Ethernet Cable Loop In Loop out. Finishing at last RPC unit. Plus Local 240vAC
Cable Distance between RPCs Max	100M. between units (Section 10.15)
240V AC Plug Pack	Required to connect power to each RPC unit
RPC Qty Per System (Maximum)	64
RPC Qty Per Node	8
Paging Zones	512
Paging Groups	512
Quiescent Current	195mA @24VDC (When screen user interface is ON)
Item No	6310-RPC

5 EWCIE and EICIE Operation

5.1 Front Control Panel

5.1.1 General

The Front Control Panel contains all the system wide controls and indicators for the EWCIE and EICIE functionality, and individual controls and indicators for the emergency warning zones (EWCIE) and WIP handsets (EICIE) according to the site-specific data (SSD). The layout of the Front Control Panel is shown below.

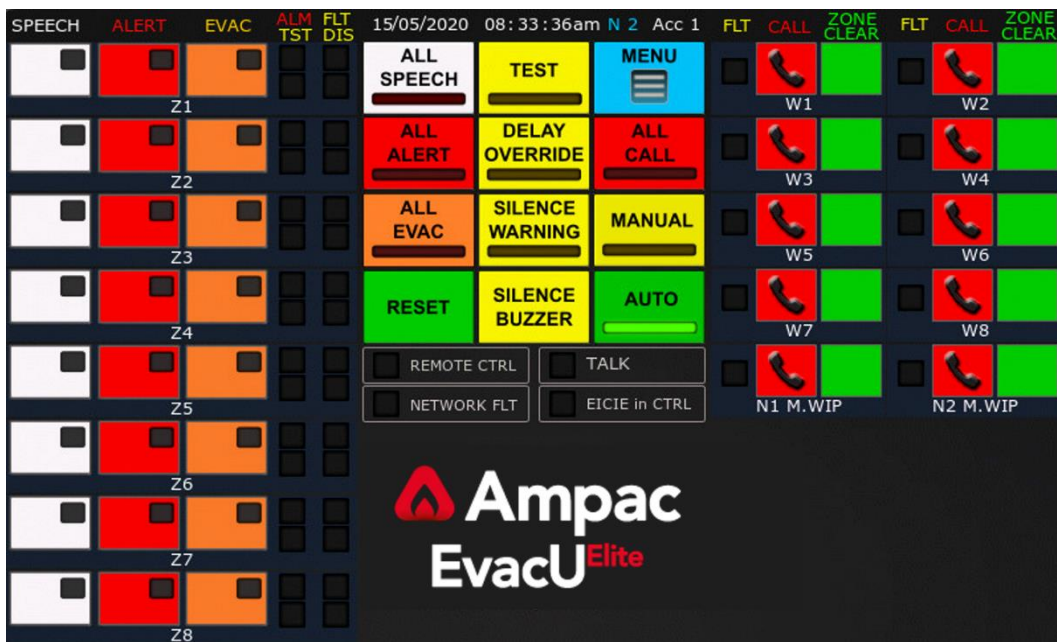

Figure 5-1 Front Control Panel

The following sections detail of the operation of each control and indicator and the applicable system (EWS or EIS).

5.1.2 Status Line (EWS and EIS)

<p>15/05/2020 08:33:36am N 2 Acc 1</p>	<p>The status line details the following.</p> <p>Date: 15/05/2020 Time: 08:33 Node No.: 2 Access level 1 – common to the EWCIE and EICIE – refer to section 3.2.</p>
--	---

5.1.3 Automatic / Manual Mode control and Indication (EWS)

The EWS shall be in the automatic or manual mode.

In the automatic mode, the EWS automatically responds to alarm signals from an EDS and broadcasts emergency warning signals (both aurally and visually) to selected emergency zones as per the SSD (referred to as phasing).

In manual mode, any phasing is halted, any new alarm signal is visually indicated but will not instigate any phasing (until the EWS is returned to the automatic mode).

While in the manual mode, emergency warning signals can be manually broadcast to selected emergency zone by activating all call or individual emergency zone manual controls (refer to section 5.1.12)

5.1.4 Automatic mode control and indicator

	<p>The green indicator is illuminated steady, when the EWCIE is in the automatic mode. To place the EWS into the automatic mode, activate the AUTO control at access level 2 or higher.</p>
---	---

5.1.5 Manual mode control and indicator

	<p>The yellow indicator is illuminated steady when the EWCIE is in the manual mode. To place the EWCIE into the manual mode, activate the MANUAL control at access level 2 or higher.</p>
---	---

5.1.6 Networking Considerations

When the EWS consists of multiple EWCIEs networked together, only one EWCIE can be in control at any one time. If the EWS is in MANUAL mode, then the REMOTE CTRL indicator is illuminated at All EWCIE, except the EWCIE that is in control. Refer to section 5.1.14.

5.1.7 Test condition control (EWS)

	<p>The yellow indicator is illuminated steady when the EWCIE is in the test condition. To place the EWCIE in the test condition, activate the TEST control at access level 2 or higher</p>
---	--

The test condition is system wide, meaning all configured emergency zones shall enter the test condition.

In the test condition, all outputs (both aural and visual) are inhibited for all emergency zones, and emergency zone status indicators are unaffected.

Not possible to enter the test condition when the EWIS is in the emergency warning condition.

The test condition can be used for training.

5.1.8 Silence warning control and indicator (EWS)

	<p>The yellow indicator is illuminated steady when the EWCIE is in the emergency warning condition and has been manually silenced.</p> <p>To silence the EWCIE, activate the SILENCE WARNING control at access level 2.</p>
---	---

Activating the SILENCE WARNING control, displays the following dialogue box.

	<p>The SILENCE WARNING has 3 options:</p> <ul style="list-style-type: none"> Silence (extinguish) the visual warning signals. Silence the audible warning signals Silence both the audible and visual signals <p>The yellow indicator is illuminated steady if the audible or visual outputs have been silenced.</p>
---	--

It is only possible to silence the EWS from the emergency warning condition.

5.1.9 Reset control (EWS)

	<p>The Emergency Warning Condition <u>must be silenced</u> prior to Reset. Use Silence Warning button.</p> <p>To reset the EWCIE from the emergency warning and/or fault warning condition, activate the RESET control at access level 2 or higher. The EWCIE shall exit the emergency warning condition (or fault warning condition) and all emergency zones shall stop broadcasting emergency warning signals.</p>
---	---

5.1.10 All controls and indicators (EWS)

The EWCIE has 3 All controls and associated indicators:

- All speech
- All alert
- All evac

5.1.11 All speech control and indicator

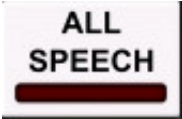
	<p>The red indicator is illuminated steady when the EWIS is in All Speech and all emergency zones are selected for live speech. To place the EWCIE in All Speech, activate the ALL-SPEECH control at access level 2 or higher. The EWCIE can be in MANUAL or AUTO mode. Any disabled zones will be inhibited.</p> <p>To cancel All Speech, activate the control again, or activate the RESET control or the ALL ALERT or ALL EVAC control.</p>
---	--

5.1.12 All alert control and indicator

	<p>The red indicator is illuminated steady when the EWCIE is in All Alert and all emergency zones are broadcasting the alert warning signal. To place the EWCIE in All Alert, activate the ALL-ALERT control at access level 2 or higher. The EWCIE must be in the MANUAL mode.</p> <p>To cancel All Alert, activate the control again, or activate the RESET control or the ALL SPEECH or ALL EVAC control.</p>
---	--

5.1.13 All evac control and indicator

	<p>The red indicator is illuminated steady when the EWCIE is in All Evac and all emergency zones are broadcasting the evacuation warning signal. To place the EWCIE in All Evac, activate the ALL-EVAC control at access level 2 or higher. The EWCIE must be in the MANUAL mode.</p> <p>To cancel All Evac, activate the control again, or activate the RESET control or the ALL SPEECH or ALL ALERT control.</p>
---	--

The EWIS maintains an Individual and All state for each emergency zone.

When the All state (Speech, Alert or Evac) is exited, the EWIS shall return to the individual state for each emergency zone.

If during the All state, an individual emergency zone control is activated, then the Individual state of the emergency zone is updated. When the All state is exited, the emergency zone will retain the new state.

For example, if the EWIS is in MANUAL mode, access level 2 with all emergency zones Off, and then:

- All alert control is activated, causing the All-Alert indicator to illuminate steady and all emergency zones broadcast the alert warning signal and illuminating their individual alert status indicators.
- Emergency zone 4 is set to Evacuation, causing emergency zone 4 to broadcast the evacuate warning signal and update its status indicators from alert to evacuate.
- All alert control is activated, which cancels the All-Alert state. This causes the All-Alert indicator to be extinguished, all the emergency zones to extinguish their individual alert indicator and to stop broadcasting the alert warning signal, except for zone 4 which is unaffected and continues to broadcast the evacuate warning signal.

5.1.14 Silence buzzer control (EWS and EIS)

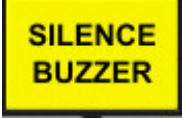
	<p>To silence the audible indication of:</p> <ul style="list-style-type: none"> the EWCIE receiving an alarm signal. the EICIE receiving a WIP call in signal. the EWCIE or EICIE entering the fault condition. <p>Activate the SILENCE BUZZER control at access level 2 or higher.</p>
---	--

5.1.15 Delay override (EWS)

	<p>The yellow indicator is illuminated steady when an alarm signal is received in an emergency zone that has a delay programmed. Once the delay has expired, the emergency zone enters the emergency warning condition (in automatic mode), and the indicator is extinguished.</p> <p>To override the delay and force the emergency zone into the emergency warning condition, activate the DELAY OVERRIDE control at access level 2 or higher, when the indicator is illuminated steady.</p> <p>Refer to section 5.4.3.1 for further information on delays</p>
---	---

5.1.16 All call control and indicator (EIS)

	<p>The red indicator is illuminated steady when an All Call has been instigated. An All Call will initiate a call to broadcast to all WIP handsets.</p> <p>To instigate an All Call, activate the All-Call control with the Master WIP handset off hook.</p>
---	--

5.1.17 Menu control (EWS and EIS)

	<p>Activating the Menu control at access level 2 will display the main menu screen. Refer to section 5.6 for further detail.</p>
---	--

5.1.18 Individual EWS controls and indicators

Refer to the highlighted section in figure 5-2 for the individual EWS controls.

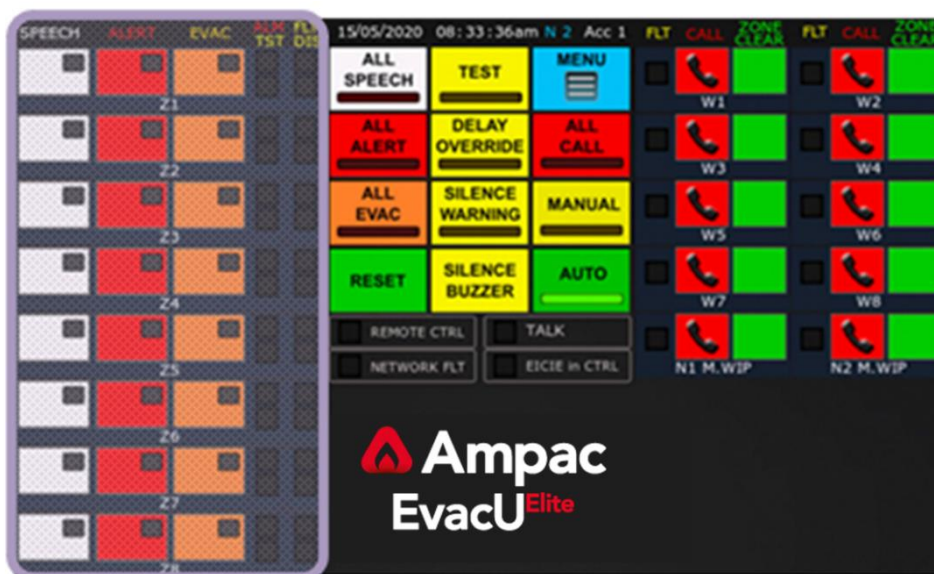

Figure 5-2 Front control panel with individual EWS controls and indicators highlighted.

Each emergency zone in the EWS has its own controls and indicators. Refer to Figure 5-3 and 5-4 below.



Figure 5-3 Emergency zone with indicators highlighted.

There are four indicators associated with each emergency zone:

- ALM – illuminated when there is an alarm signal present in the emergency zone.
- FLT – illuminated when there is a fault with the emergency zone and associated transmission path.
- TST – illuminated when the EWS is in the Test condition.
- DIS – illuminated when the emergency zone is disabled.



Figure 5-4 Emergency zone with controls highlighted.

There are three controls with associated indicators for each emergency zone:

- **SPEECH** – indicator is illuminated RED when the emergency zone is selected for live speech. Live speech is broadcast when the PTT control of the microphone is activated and the TALK indicator is illuminated. To select the emergency zone for speech, activate the speech control at access level 2, when the EWS is in AUTO or MANUAL.
- **ALERT** – indicator is illuminated RED when the alert warning signal is being broadcast to the emergency warning zone. To manually broadcast the alert warning signal, activate the ALERT control. To cancel the broadcast, activate the ALERT control. To select the emergency zone for ALERT, activate the control at Access level 2, when the EWS is in MANUAL.
- **EVAC** - indicator is illuminated RED when the evacuate warning signal is being broadcast to the emergency warning zone. To manually broadcast the evacuate warning signal, activate the EVAC control. To cancel the broadcast, activate the EVAC control. To select the emergency zone for EVAC, activate at Access level 2, when the EWS is in MANUAL.

Each zone has an associated descriptor (“Z1” in the above example)– which is editable. Refer to section 5.6.4.

5.1.19 Individual EIS controls and indicators

Refer to the highlighted section in figure 5-5 for the individual EIS controls.



Figure 5-5 Front control panel with the individual EIS controls and indicators highlighted.

Each WIP handset in the EIS has its own controls and indicators. Refer to Figure 5-6 and 5-7 below.



Figure 5-6 WIP handset with controls highlighted.



There are two controls associated with each WIP.

- CALL – this control is used to establish a call to the WIP handset and answer an incoming call from the WIP handset. Refer to section xx for further detail.
- ZONE CLEAR – this control is used to show that the zone associated with the WIP handset location has been cleared of occupants – or as detailed in the site emergency management plan. To cancel activate the control again. Control is only active when the master handset is off hook.



Figure 5-7 WIP handset with indicators highlighted.

There are three indicators associated with WIP handset.

FLT	Illuminated when there is a fault associated with the WIP handset and associated transmission path
	CALL indicator – flashes red when a call is being established to a WIP handset, or there is an incoming call from a WIP handset
	ZONE CLEAR indicator – illuminates steady when the ZONE CLEAR control has been activated.

5.1.20 Remote control indicator

	If there are multiple EWCIEs networked in the EWS, the REMOTE CTRL indicator is illuminated steady if the system is in MANUAL mode and another EWCIE is in control.
---	---

5.1.21 Network fault indicator

	The NETWORK FLT indicator is illuminated steady if there is a network fault or a networked EWCIE is not detected
---	--

5.1.22 Talk indicator.

	The TALK indicator is illuminated steady when the Audio channel is open, in response to the PTT control of the emergency microphone being activated.
---	--

5.1.23 EICIE in control indicator

	If there are multiple EICIEs networked in the EIS, the EICIE in CTRL indicator is illuminated steady if another EICIE is in control (master WIP handset is off hook)
---	--

5.2 Additional Front Panels (GUIs)

From figure 5.1, the standard configuration of a GUI Front Panel Control can support 8 Emergency zones and 16 WIP handsets.

When the site configuration requires over 8 emergency zones and/or 16 WIP handsets, additional Front Panels can be added. Refer to the Programming Manual MAN3142 for further information.

5.3 Led Indicators

The EWCIE is fitted with the following LED indicators.



Figure 5-8 LED Indicators

5.3.1 Power

Power - power is applied to the EWCIE.

5.3.2 Power Fault

Power Fault – fault associated with the PSE – loss of mains, loss of standby power source, battery charger fails, and high battery impedance.

5.3.3 Fault

Fault – EWCIE or EICIE is in the fault warning condition.

5.3.4 System Fault

System Fault – System fault condition on the EWCIE or EICIE

5.3.5 Delays

The indicator is illuminated steady when one or more emergency zones are configured to introduce a delay before entering the emergency warning condition (in Automatic mode) on receipt of an alarm signal in the emergency zone.

The indicator shall flash when the delay is active (alarm signal received in an emergency zone with a delay configured)

The indicator is extinguished when the EWCIE is in the emergency warning condition.

Refer to section 5.4.4

5.3.6 Earth Fault

Earth Fault – Earth fault condition on the EWCIE or EICIE

5.3.7 Disabled

Disabled – EWCIE is in the disabled condition. At least one emergency zone is disabled.

5.3.8 Alarm

Alarm – Alarm signal. At least one emergency zone has an active alarm signal. See 5.1.12.

5.3.9 Test

Test – EWCIE is in the test condition. See section 5.1.4

5.4 EWS Operation

5.4.1 General

The purpose of the Emergency Warning System is to warn the occupants at a site of an emergency condition and facilitate an orderly evacuation, by broadcasting (both visually and aurally) emergency warning signals to designated emergency zones according to a pre-configured sequence (phasing) and permitting live speech into selected emergency zones.

Additional functionality is provided to manually control the broadcast of emergency warning signals, configure delays before commencing the emergency broadcasts, silence the emergency warning signals, disable emergency zones and test the EWS without broadcasting emergency warning signals.

5.4.2 Live Speech

The EWS can be used to broadcast live speech in automatic or manual mode. Refer to section 5.1.3.

To broadcast live speech (at any time), the emergency zones must be selected by using the ALL-SPEECH control (refer to section 5.1.7.1)– for all emergency zones or using the individual SPEECH controls (refer to section 5.1.12). Once the emergency zones have been selected, the PTT control on the microphone is activated, and any audio being broadcast into the selected emergency zones is muted, and the TALK indicator (refer section 5.1.16) is illuminated to indicate that the audio channel is available to use. At the completion of the live speech broadcast, the PTT is released, the TALK indicator will extinguish, and the audio broadcast into the selected emergency zones will be reinstated to the condition prior to the live speech.

If the EWS consists of more than one EWCIE networked together, then the selection of emergency zones can take place at multiple EWCIEs. When the PTT control on a microphone is activated, then the REMOTE CTRL indicator (see section 5.1.14) is illuminated steady at all other EWCIE to show that another EWCIE is in control. When the PTT control is released, the REMOTE CTRL indicator is extinguished.

5.4.3 Automatic Operation

For the EWS to automatically respond to an emergency warning condition, the EWS must be in the AUTOMATIC mode. In AUTOMATIC mode the green AUTO indicator is illuminated steady. Refer to section 5.1.3

When an alarm signal is recognised, the EWS will respond by entering the emergency warning condition and broadcasting emergency warning signals to the designated emergency zones in a pre-configured sequence, referred to as phasing or sequencing. In addition to broadcasting the emergency warning signals, the EWS can also activate warning devices (or fire alarm devices), which are Visual Alarm Devices (VADs), Visual warning devices and vibrating devices.

5.4.4 Delays

There is an option to delay the broadcast of emergency warning signals after the alarm signal is received. If a delay is configured, the DELAY indicator is illuminated (refer to section 5.3.5). When the delay is active (after an alarm signal is received in an emergency zone with a delay) the DELAY indicator flashes, and the Delay Override indicator (section 5.1.9) is illuminated. Once the delay has expired and the EWS has entered the emergency warning condition, the indicators (DELAY and Delay Override) are extinguished and remain off until the EWS is reset from the emergency warning condition.

The Delays can be switched On and Off at the EWCIE. Refer to section 6.12.

Delays can be programmed at Access Level 3 on each zone Using the zone slider control. This allows a delay setting from 30 seconds up to 6000 seconds in 30 second increments and prompts the user to Save and

changes made. Refer to section 6.4. Alternatively, Delays can be programmed in the **configuration** file based on a zone response or within a specified sequence of events– refer to MAN3142 EvacU^{ELITE} **Programming Manual**

5.4.5 Silence

To silence the broadcast, the SILENCE WARNING control must be activated at access level 2. Option to silence the audio or visual broadcast or both. Refer to section 5.1.5.

5.4.6 Reset

To stop the phasing and silence the broadcast of emergency signals, the EWS can be reset from the emergency warning condition using the RESET control. Refer to section 5.1.6. The emergency warning condition must be silenced prior to operating the RESET control.

Note if alarm signals are present when the reset operation is complete, then once the reset operation is complete, the EWS will respond to the alarm signals and commence phasing, subject to any programmed delays.

5.4.7 Manual Operation

To manually control Alert and Evac functions, the system must be in MANUAL mode. When in MANUAL mode the yellow MANUAL indicator is illuminated steady. Refer to section 5.1.3.

To manually instigate the broadcast of emergency warning signals (alert and evacuation), then using the All Call (refer to section 5.1.7) or individual (refer to section 5.1.12), controls select the required signals to be broadcast to the emergency zones.

To silence the broadcast, the SILENCE WARNING control must be activated at access level 2. Option to silence the audio or visual broadcast or both. Refer to section 5.1.5.

If phasing is running when the EWS is switched to MANUAL mode, then the phasing is halted, and will resume when the EWS is switched back to AUTOMATIC mode. Any emergency warning signals manually activated in MANUAL mode shall continue to be broadcast until overridden by phasing with a higher priority emergency warning signal (Evacuate will override Alert, Alert will not override Evacuate)

Any alarm signals recognised while the EWS is in MANUAL mode shall be indicated. Refer to section 5.1.12. Phasing associated with these alarm signals is halted until the EWS is returned to AUTOMATIC mode.

When the EWS consists of multiple EWCIEs networked together, only one EWCIE can be in control at any one time, and the REMOTE CTRL indicator is illuminated at All EWCIE, except the EWCIE that is in control. Refer to section 5.1.14.

Each EWCIE is assigned a priority. A higher priority EWCIE can take control from a lower priority EWCIE, by activating the MANUAL control at the higher priority EWCIE. Refer to the Programming Manual for information on setting priorities.

5.4.8 Disabling Emergency Zones

There is facility to disable one or more emergency zones.

When an emergency zone is disabled, the emergency zone status indication – Speech, Alert, Evac, Fault and Test are extinguished, the audio and visual outputs are de-activated.



The individual emergency zone ALM indicator is unaffected. See section 5.1.12.

The system wide ALARM indicator is unaffected. See section 5.3.8

The individual emergency zone DIS indicator is illuminated steady. See section 5.1.12.

The system wide DISABLE indicator is illuminated steady. See section 5.3.7

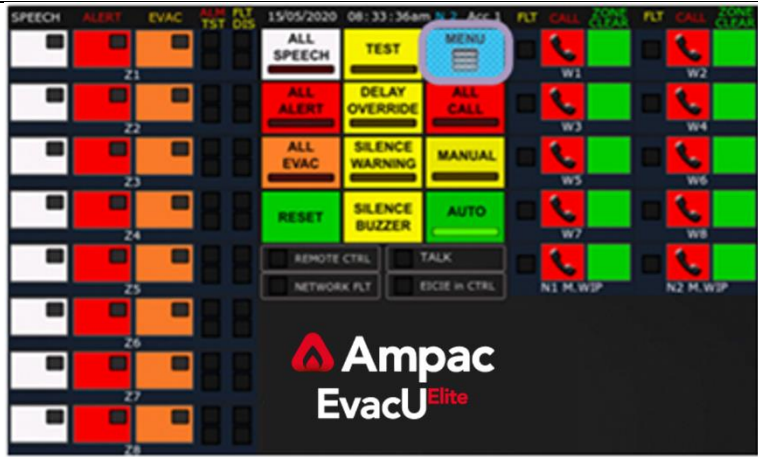
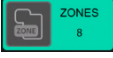
5.4.9 To disable one or more emergency zones:

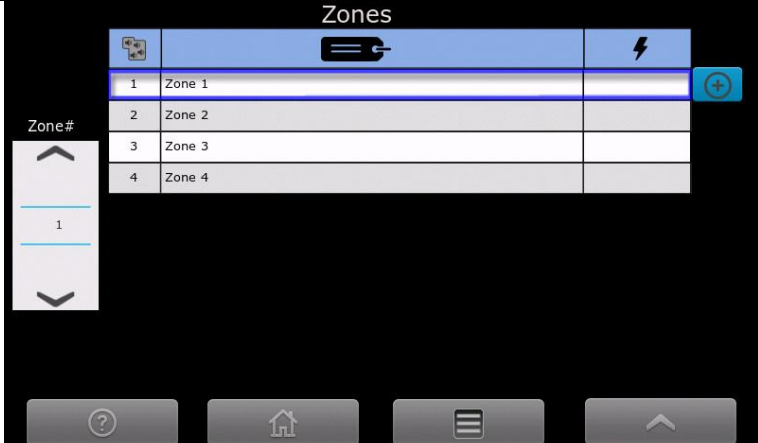
<p>Activate the MENU control.</p> 																
<p>Activate the ZONE control.</p> 																
<p>To Disable Zone 1, activate the  control on the Zones screen.</p>	 <table border="1" data-bbox="687 1480 1326 1653"> <thead> <tr> <th>Zone#</th> <th>Zone Name</th> <th>Status</th> </tr> </thead> <tbody> <tr> <td>1</td> <td>Zone 1</td> <td></td> </tr> <tr> <td>2</td> <td>Zone 2</td> <td></td> </tr> <tr> <td>3</td> <td>Zone 3</td> <td></td> </tr> <tr> <td>4</td> <td>Zone 4</td> <td></td> </tr> </tbody> </table>	Zone#	Zone Name	Status	1	Zone 1		2	Zone 2		3	Zone 3		4	Zone 4	
Zone#	Zone Name	Status														
1	Zone 1															
2	Zone 2															
3	Zone 3															
4	Zone 4															

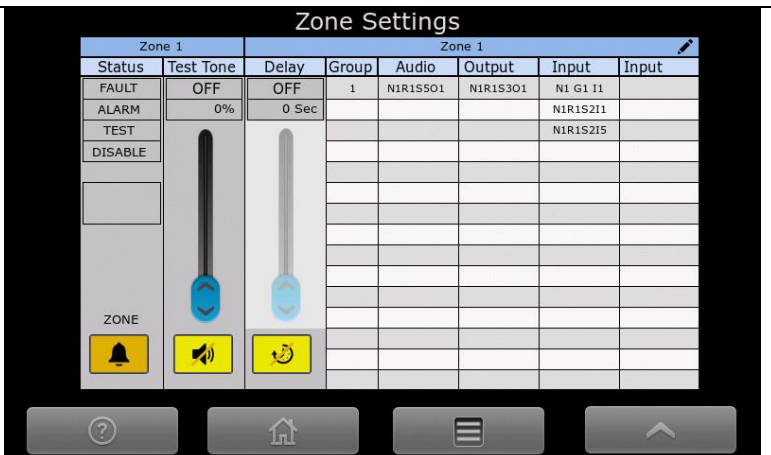

On the Zone Settings screen, activate the  control

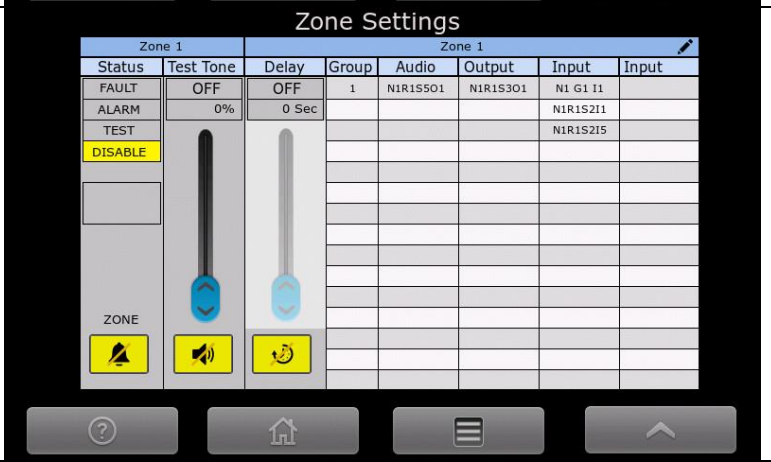

Zone setting screen updated to show the disable



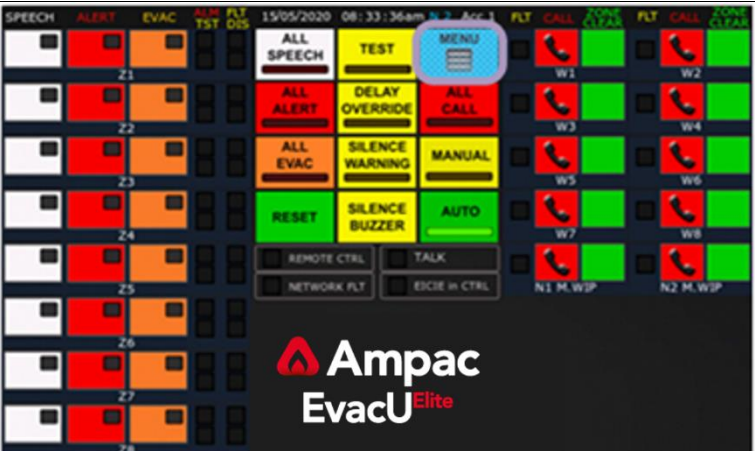

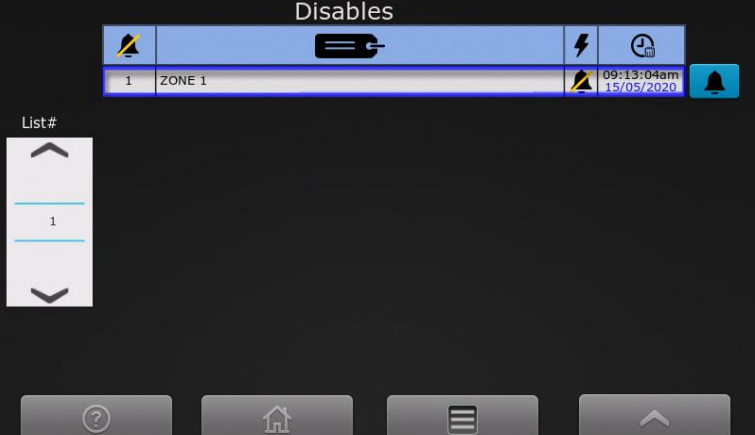

5.4.10 To view the disabled emergency zones

<p>Activate the MENU control.</p>	
<p>Activate the DISABLE control.</p>	
<p>Screen display the list of disabled zones and details the date and time when the zone was disabled.</p>	

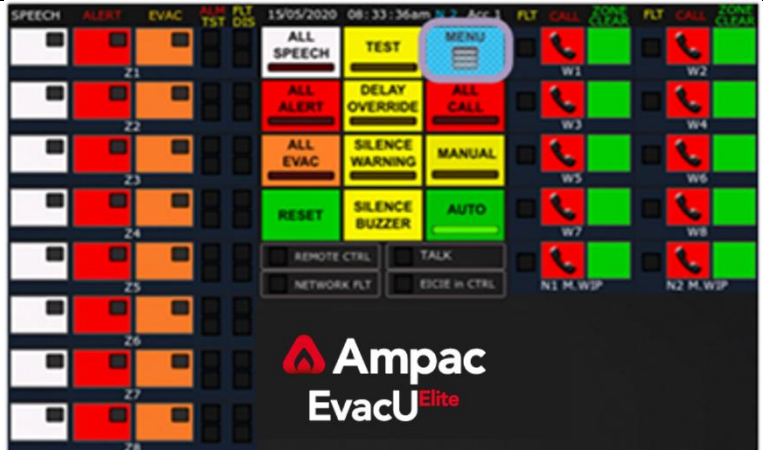
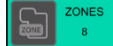
5.4.11 Activating the Test Tone

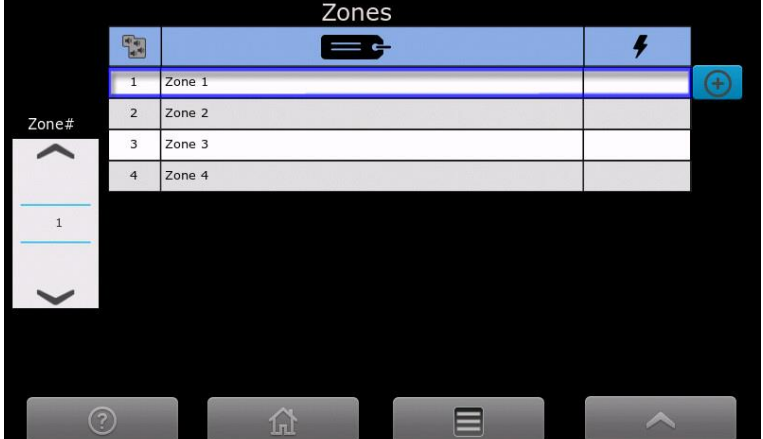
A test tone can be activated in an emergency zone.

<p>Activate the MENU control.</p> 																
<p>Activate the ZONE control.</p> 																
<p>To activate the test tone for zone 1, activate the  control on the Zones screen.</p>	 <table border="1" data-bbox="686 1400 1276 1568"> <caption>Zones</caption> <thead> <tr> <th>Zone#</th> <th>Zone Name</th> <th>Test Tone</th> </tr> </thead> <tbody> <tr> <td>1</td> <td>Zone 1</td> <td></td> </tr> <tr> <td>2</td> <td>Zone 2</td> <td></td> </tr> <tr> <td>3</td> <td>Zone 3</td> <td></td> </tr> <tr> <td>4</td> <td>Zone 4</td> <td></td> </tr> </tbody> </table>	Zone#	Zone Name	Test Tone	1	Zone 1		2	Zone 2		3	Zone 3		4	Zone 4	
Zone#	Zone Name	Test Tone														
1	Zone 1															
2	Zone 2															
3	Zone 3															
4	Zone 4															

On the Zone Settings screen, activate the  control to turn the test tone on and off. The volume of the test tone is adjusted by the associated slider control.

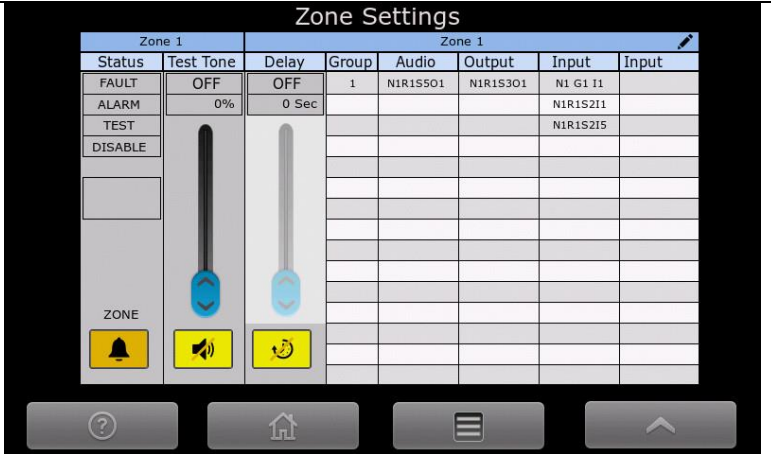

Zone 1		Zone 1					
Status	Test Tone	Delay	Group	Audio	Output	Input	Input
FAULT	OFF	OFF	1	N1R1S501	N1R1S301	N1 G1 I1	
ALARM	0%	0 Sec				N1R1S211	
TEST						N1R1S215	
DISABLE							

5.4.12 Test Condition

There is a facility to test all emergency zones. Refer to section 5.1.4

When in the test condition, indications are unaffected.

The emergency zone TEST indicators are illuminated steady. Refer to section 5.1.12.

The system wide test indicator is illuminated steady (see section 5.3.9)

Activate the TEST  control.

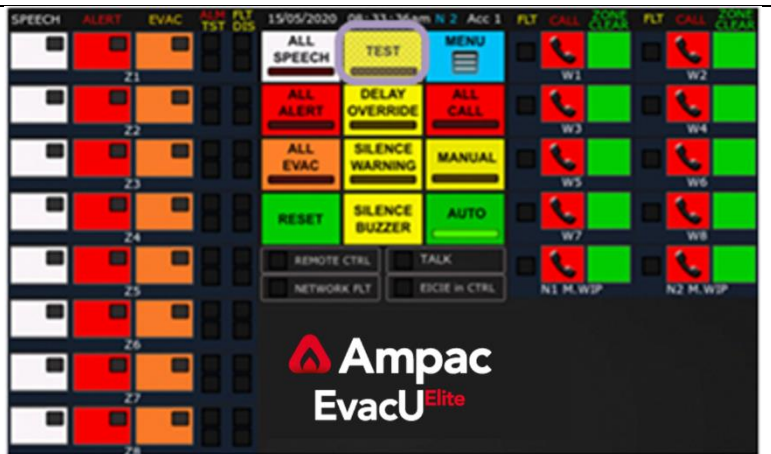

The main screen has been updated, to show all emergency zones in the test condition, and the TEST indicator is illuminated steady.

The EWS can now be placed in the manual mode, and all call or individual emergency zone controls activated, with ONLY the indication affected.

No audio or visual signals are broadcast in the test condition.

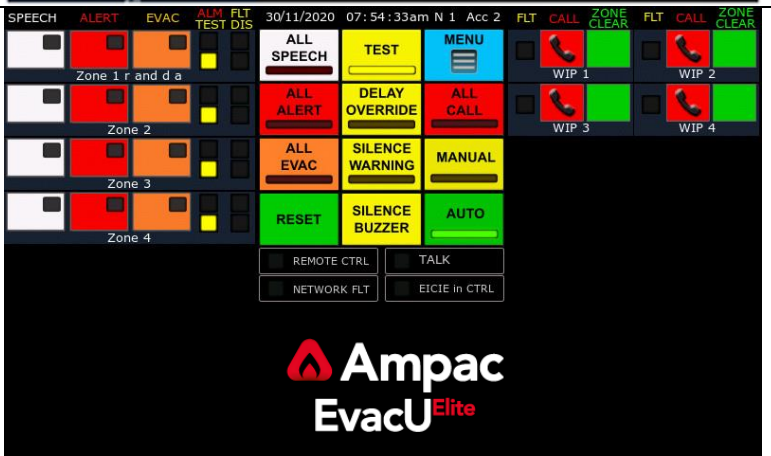

5.5 EIS Operation

5.5.1 General

The purpose of the Emergency Intercom System is to provide a dedicated communications system between the Main Fire Warden (usually situated in the fire control room) and the Floor Wardens, situated at the Warden Intercom Points (WIP), which are normally located on each floor of a building near the egress points.



The EIS is used by fire wardens and other suitably trained personnel to assist in the evacuation, relocation or direction of personnel in an emergency situation.

To achieve the above, the EIS provides the following communications:

- Establish a call from the EICIE handset to a handset at WIP.
- Establish a call from a WIP handset to an EICIE handset.
- Support a multi-party conference (up to 5 WIP handsets) in a full duplex call.
- Support a half-duplex All-Call broadcast – to all WIP handsets.



5.5.2 Establish a call from the EICIE handset to a WIP handset.

To establish a call from the EICIE handset to a WIP handset, the following procedure is followed:

1	Remove the handset from the cradle at the EICIE (off hook)	
2	Confidence tone will be broadcast in the earpiece, to indicate the EICIE has recognised the handset going off hook.	
3	Select the WIP handset to call by activating the appropriate Call control (refer to section 5.1.13)	
4	The call indicator flashes, and a ring tone replaces the confidence tone in the earpiece. The buzzer on the selected WIP handset is pulsing (matching the frequency of the ring tone).	
5	To answer the call, the WIP handset is taken off hook, and the call indicator goes steady. A full duplex call between the handset at the EICIE and the handset located at the WIP has been established.	
6	To terminate the call at the EICIE, place the handset at the EICIE on hook. If the handset at the WIP remains off hook, then the EICIE treats this as a call from a WIP handset, and the ring tone is broadcast in the earpiece of WIP handset and the corresponding Call indicator flashes at the EICIE. Refer to section 5.5.3, step 3.	
7	To terminate the call at the WIP handset, place the WIP handset into the cradle (on hook). The Call indicator is extinguished at the EICIE.	

5.5.3 Establish a call from the WIP handset to the EICIE handset.

To establish a call from a WIP handset to the EICIE handset, the following procedure is followed:

1	Remove the WIP handset from the cradle (off hook) at the WIP.	
2	Ring tone will be broadcast in the earpiece of the WIP handset.	
3	The call indicator corresponding to the WIP handset that is off hook with flash at the EICIE. The panel buzzer at the EICIE will pulse (at the same cadence as the ring tone)	
4	To establish the call, remove the handset from the cradle at the EICIE. Confidence tone will be broadcast in the earpiece. Activate the flashing Call control. The Call indicator goes steady. A full duplex call between the handset at the WIP and the handset at the EICIE has been established.	
5	To terminate the call at the EICIE, place the handset at the EICIE on hook. If the handset at the WIP remains off hook, then the EICIE treats this as a call from a WIP handset, and the ring tone is broadcast in the earpiece of WIP handset and the corresponding Call indicator flashes at the EICIE. Refer to section 7.5.3, step 3.	
6	To terminate the call at the WIP handset, place the WIP handset into the cradle (on hook). The Call indicator is extinguished at the EICIE.	

5.5.4 Establishing a multi-party conference call

The EICIE supports a full duplex multi-party conference call that supports up to 5 WIP handsets and the handset at the EICIE.

A single full duplex call is established – refer to section 5.5.2 for EICIE handset to WIP handset and section 5.5.3 for WIP handset to EICIE handset.

If another WIP handset is taken off hook, the corresponding Call indicator shall flash at the EICIE, and by activating the Call control, the WIP is added to the call.

To call another WIP, activate the Call control associated with the WIP, the call indicator will flash until the WIP handset is taken off hook.



To cancel a call from the WIP handset, the WIP handset is placed on hook, and the corresponding Call indicator is extinguished.

To cancel a call to the WIP handset, the Call control is activated. If the WIP remains off hook, the Call indicator shall flash, and the ring tone is broadcast in the earpiece of the WIP handset.

5.5.5 All Call broadcast.

The EICIE supports a half-duplex call to all WIP handsets.

To establish the All call, the following procedure is followed:

1	Remove the handset from the cradle at the EICIE (off hook)	
2	Confidence tone will be broadcast in the earpiece, to indicate the EICIE has recognised the handset going off hook.	
3	Activate the All-call control. The red indicator illuminates steady.	
4	All the Call indicators flash	
5	As the WIP handsets are taken off hook the associated Call indicator goes steady to indicate the half duplex call the WIP handset has been established.	
6	Calls to the WIP handsets can be terminated at the WIP, by placing the WIP on hook, at the EICIE by activating the Call control, or by placing the handset at the EICIE on hook.	

5.5.6 Networked EICIE

The EIS can consist of a network of EICIEs.

When establishing a call from a EICIE handset to a WIP handset, the same procedure as detailed in section 5.5.2 is followed, except when the handset at the EICIE is taken off hook, the EICIE in CTRL indicator (see section 5.1.17) is illuminated in all other EICIEs to show that the EIS is in use.

When establishing a call from a WIP handset to a EICIE handset, the same procedure as detailed in section 5.5.3 is followed, except all EICIE handsets ring, and the first EICIE handset taken off hook has control of the EIS and can answer the call from the WIP. Once the call has been answered at an EICIE, all EICIE handsets cease ringing and the EICIE in CTRL indicator is illuminated in all other EICIEs to show that the EIS is in use.

The EIS has the same priority scheme as the EWS (see clause 5.4.3).

If the handset at an EICIE with a higher priority is taken off hook while the EIS is in use, then the current calls in progress are transferred to the EICIE with the higher priority. The WIP handsets that are off hook will revert to the ring tone and the calls can be established at the higher priority EICIE as required.

The handset at the lower priority EICIE is treated as a WIP handset – and will revert to a ring tone. A call between the higher priority EICIE and the lower priority EICIE can be established if required.

If a handset at a lower priority EICIE is taken off hook while the EIS is in use, then ring tone is present in the earpiece, and the call can be established with the higher priority EICIE if required.

If the EWS is in manual mode, then the EWICIE that is in control, shall also be in control of the EIS.

5.5.7 Ring, On Hold and Confidence Tones

The ring and confidence tones are based on the requirements specified in AS/CA S002 – as stated in the NOTE of clause 7.3 of AS 4428.4:2016.

The tones are a combined signal of 400Hz and 450Hz.

The Ring and On-hold tones are the same.

Due to the requirements of clause 7.3.4 and 7.3.5 of AS 4428.4:2016, the cadence specified in S002 (0.4s on, 0.2 s off) could not be followed.

The cadence used is 0.5 sec on and 0.5 sec off – to meet the requirement of clause 13.7.2 of AS 4428.4:2016 (Clauses 7.3.4 and 7.3.5 require the cadence to match the flash rate of the call indicator, and clause 13.7.2 specifies the allowable flash rate of the call indicator)

5.6 Remote Paging Console

See Manuals below.

MAN 3189 RPC Operators Manual

MAN 3190 RPC Installation guide.

MAN 3142 EvacUElite Programming Manual

6 Menu System

	<p>Activating the Menu control at access level 2 will display the main menu screen. Refer to figure 6-1.</p>
---	--





The main menu screen.



Figure 6-1 Main menu screen

6.1 General

The following controls are available on all screens.

	<p>Help Button -</p>
	<p>Home screen – reverts the display back to the default screen</p>
	<p>Back to the main menu screen</p>
	<p>Back to the previous screen</p>

6.2 Access levels

Refer to section 3.2 for detail on access levels.

The current access level of the node is displayed on the default screen, refer to section 5.1.2

When a control / facility requiring access level 3 is attempted (and the Evacu^{ELITE} is at access level 2 – outer door open), the following screen is displayed, prompting the user to enter their UserID and password.

The access level is property of a UserID.

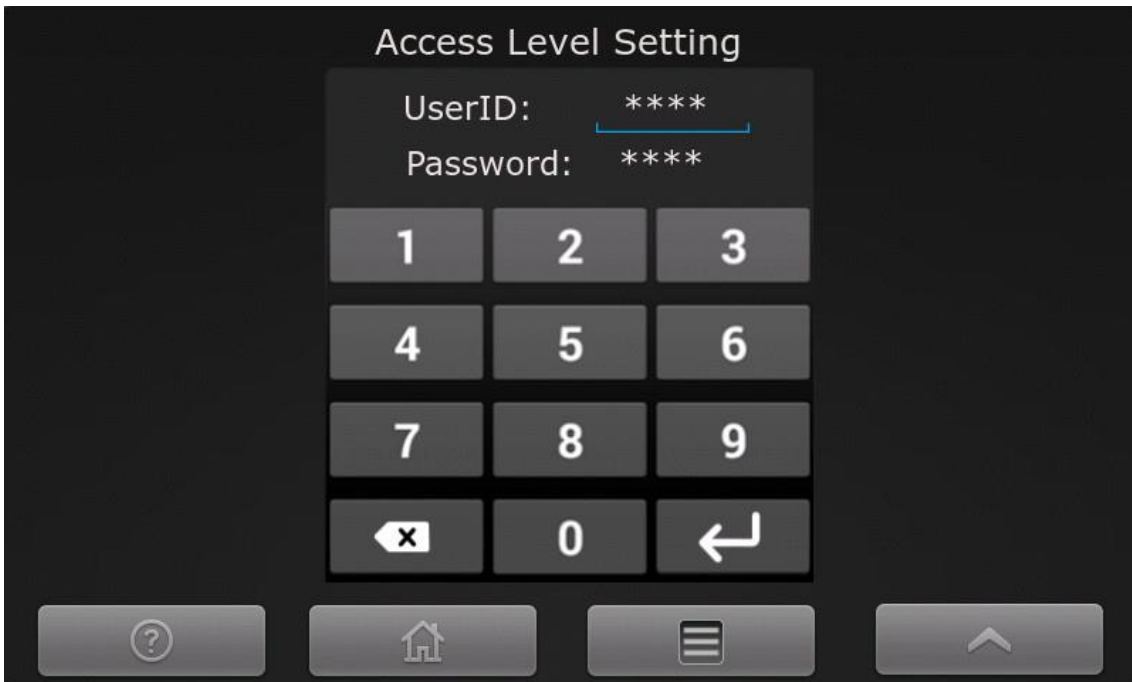



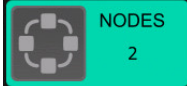





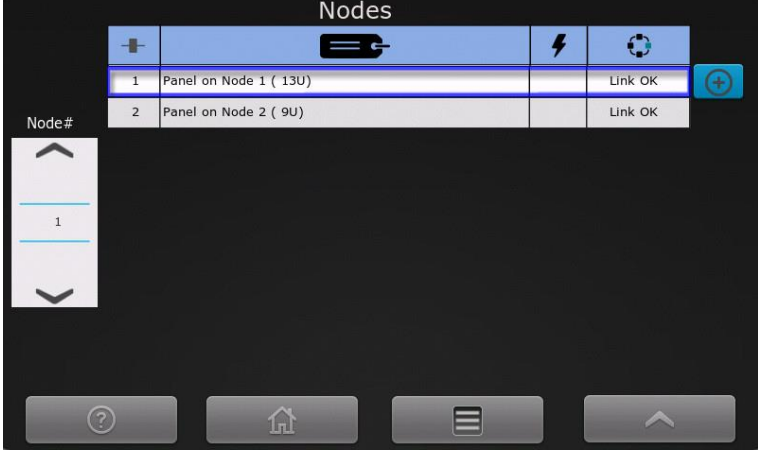
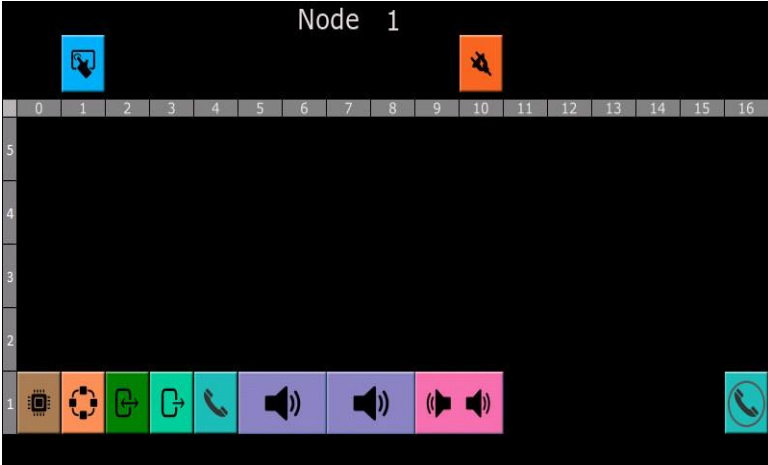



















Figure 6-2 Access level screen

	Backspace button
	Enter Button

6.3 Nodes

To access the Nodes screen, the following controls are activated.

<p>1 Menu control</p>	
<p>2 Node's control</p>	
<p>3 Nodes Screen</p> <p>Shows a list of nodes configured in the system.</p> <p>If there are any faults on a node, there will be  in the  column.</p> <p>The  column shows the status of the network.</p> <p>If the node reference has the following symbol , then there is a high-level interface from the node to a FireFinder^{PLUS} FDCIE.</p> <p>Activate the  control for detail on the node.</p>	
<p>4 Individual Node Screen</p> <p>Shows a layout of the node, racks 1 to 5 and slots 1 thru 16.</p> <p>The type of board fitted is denoted by the ICON.</p> <p>Refer to the table below.</p>	

Icon	Description
	Distribution CPU card, located in rack 1, slot 0. To view the status of this card, select the Distribution CPU icon.
	Network interface card, located in rack 1, slot 1. To view the status of this card, select the Network interface card Icon.
	Multi-purpose interface card, located in rack 1, slot 2. To view the status of this card, select the Multi-purpose interface card icon.
	Multi-purpose interface (as above) – with a HLI fitted to the FireFinder ^{PLUS} . The fault condition () is due to a link error to the FireFinder ^{PLUS} . To view the status of this card, select the Multi-purpose interface card icon.
	Multi-purpose output card, located in rack 1, slot 3. To view the status of this card, select the Multi-purpose output icon
	Quad radial EIS line card, located in rack 1, slot 4. To view the status of this card, select the Quad radial EIS line card icon
	Dual 25-watt amplifier card, located in rack 1, slots 5 and 6. To view the status of this card, select the Dual 25-watt amplifier card Icon
	50-watt amplifier card, located in rack 1, slots 7 and 8. A second card if fitted in slots 9 and 10. To view the status of this card select the 50-Watt amplifier card Icon
	Dual loop EIS line card, located in rack 1, slot 16. To view the status of this card, select the Dual loop EIS line card Icon.
	Graphical user Interface – located on the inner door. To view the status of this card, select the Graphical user interface Icon
	Power supply – located beneath rack 1. To view the status of this card, select the Power supply Icon.
	More System Icons - Not shown on the Node 1 screen illustration.
	150W HPA High Power Amplifier
	PAIC Module icon – Bosch Praesensa interface. (AUS)
	RPC Remote Paging Console icon
	Audio Line Card icon
	SmartView Icon. A Graphical Interface Package which can potentially control EWCIE and EICIE controls as well as the Fire System controls and indications and building map layers





6.3.1 Distribution CPU card

The Distribution CPU card has 4 inputs and 3 outputs (refer to section 4.2.5.1). The status screen for the Distribution CPU card shows the module status and the status of the 4 inputs as follows:



Figure 6-3 Distribution CPU card status screen

The following explains the content of the screen.

	Display the previous module in the node
	Display the next module in the node
	Display the inputs – inputs are currently displayed as the icon is highlighted
	Press to display the outputs. The Distribution CPU card has 3 outputs

Type	Location	Sw. Version	Hw. Version	Status
CPU	N1 R1 S0	01.01.08	00.01.000	Normal

Figure 6-4 Distribution CPU card status

Above is the module type “CPU”, location – Node 1, Rack 1, Slot 0, Software version 01.01.08, hardware version 00.01.000 and status is Normal.

Number	Zone	Description	State	Status	Action
1	1	Input 1	Off	Normal	ALERT

Figure 6-5 Input status.

There is a record for each of the 4 inputs, showing the allocated zone, description, state, status and action.

Figure 6-6 shows the status of the 3 outputs on the Distribution CPU, note the  icon is highlighted denoting outputs are displayed.

MODULE

Type	Location	Sw. Version	Hw. Version	Status
CPU	N1 R1 S0	01.01.09	15.15.255	Normal

Number	Zone	Description	State	Status	Action
1	0	Output 1	Off	Normal	
2	0	Output 2	On	Normal	
3	0	Output 3	Off	Normal	





?

🏠

☰

⤴

Figure 6-6 Distribution CPU card status - showing the outputs.

There is a record for each of the 3 outputs, showing the allocated zone number, descriptor, state, status and action.

6.3.2 Network interface card

The status screen for the Network interface card is shown in figure 6-7. There are no inputs or outputs associated with this card.

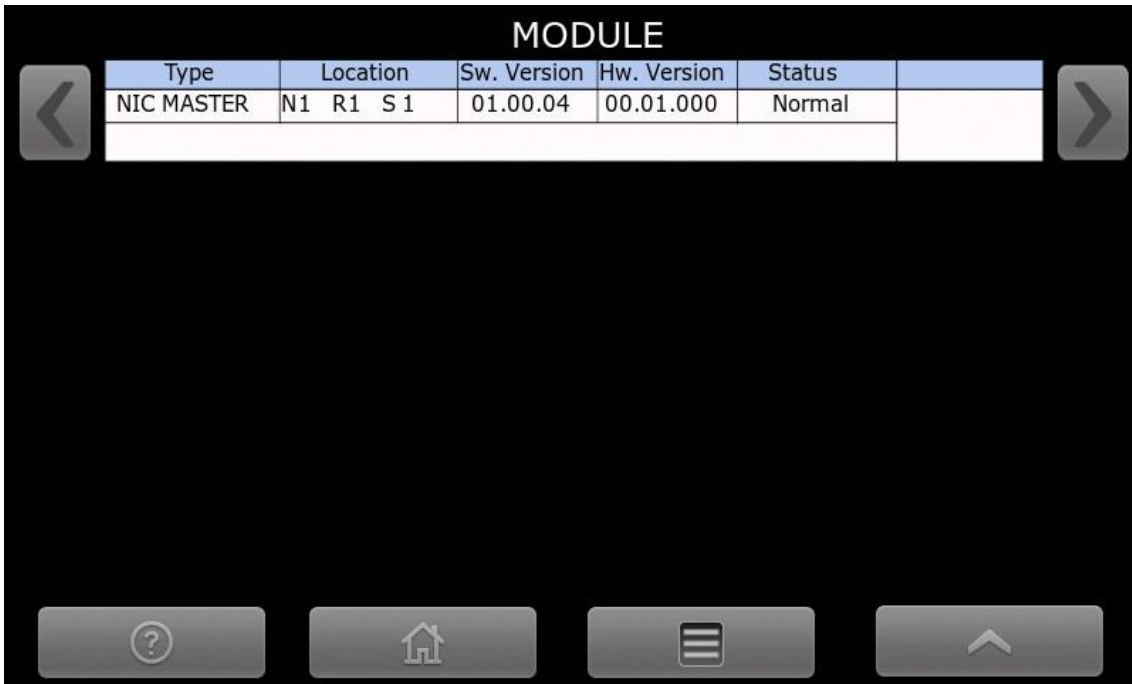



Figure 6-7 Network interface card status screen

The following explains the content of the screen.

	Display the previous module in the node
	Display the next module in the node

Type	Location	Sw. Version	Hw. Version	Status
NIC MASTER	N1 R1 S 1	01.00.04	00.01.000	Normal

Figure 6-8 Network interface card status

Above is the module type “NIC PRIMARY”, the primary denotes that this NIC is the current primary of the network. The location is Node 1, Rack 1, Slot 1 (adjacent to the DCPU), Software version 01.00.04, hardware version 00.01.000 and Status is Normal.

6.3.3 Multi-purpose interface card

The multi-purpose interface card has 8 inputs, 2 outputs and a HLI to the FireFinder ^{PLUS} (refer to section 4.2.5.3). The status screen for the Multi-purpose interface card shows the modules status and the status of the virtual (HLI) inputs (if fitted).

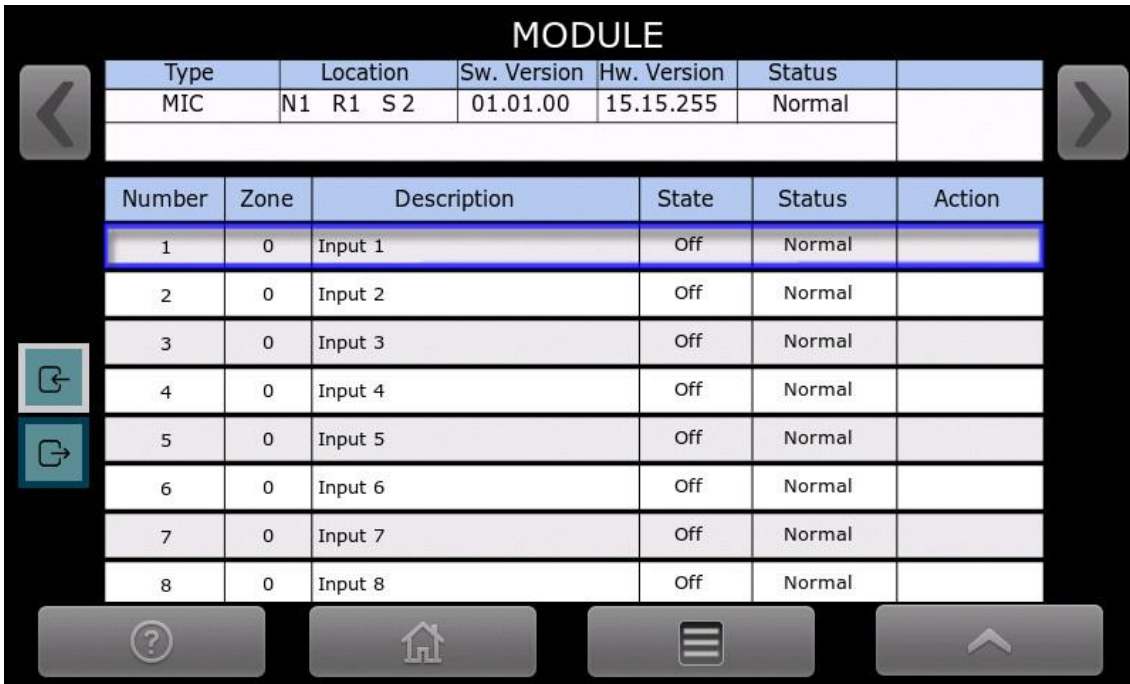







Figure 6-9 Multi-purpose interface card status screen

The following explains the content of the screen.

	Display the previous module in the node
	Display the next module in the node
	Display the virtual (HLI based) inputs – inputs are currently displayed as the icon is highlighted. If the HLI is not configured, then this icon is not displayed
	Press to display the inputs. The multi-purpose interface card has 8 inputs
	Press to display the outputs. The multi-purpose interface card has 2 outputs

Type	Location	Sw. Version	Hw. Version	Status
MIC	N1 R1 S 2	01.01.00	15.15.255	Normal

Figure 6-10 Multi-purpose interface card status

Above is the module type “MIC”, location – Node 1, Rack 1, Slot 2, Software version 01.01.00, hardware version 15.15.255 and status is Normal.

The input record is the same as the Distribution CPU – refer to section 6.3.1.

Figure 6-11 shows the status of the 2 outputs on the Multi-purpose interface card, note the  icon is highlighted denoting that outputs are displayed.

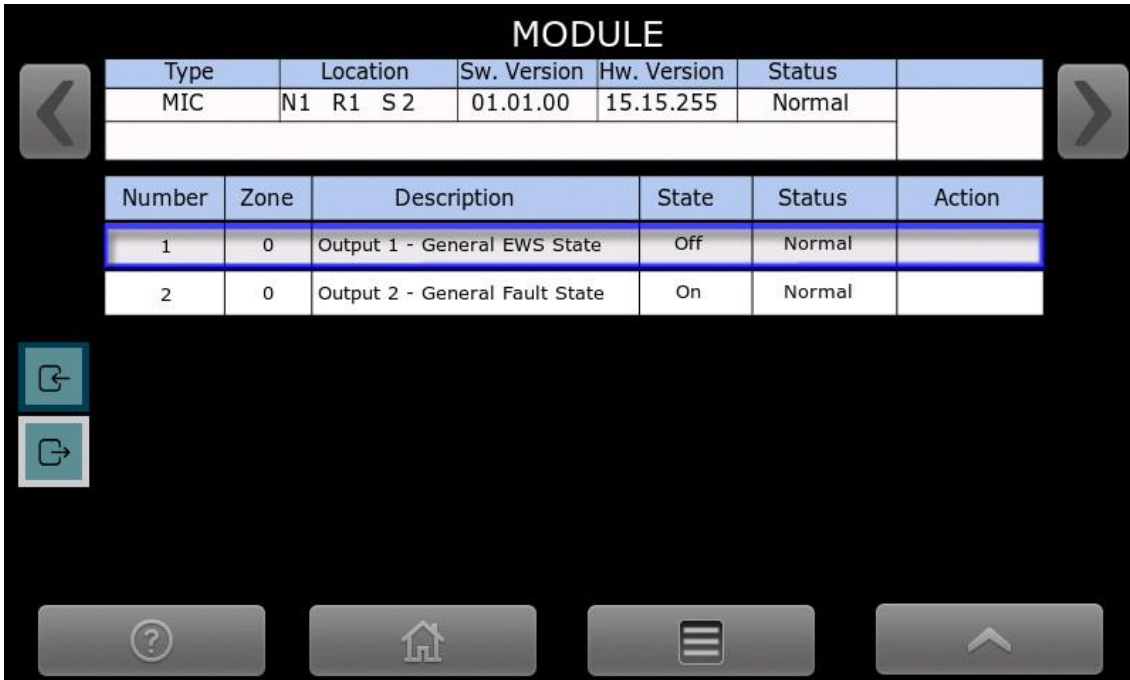

MODULE					
Type	Location	Sw. Version	Hw. Version	Status	
MIC	N1 R1 S2	01.01.00	15.15.255	Normal	

Number	Zone	Description	State	Status	Action
1	0	Output 1 - General EWS State	Off	Normal	
2	0	Output 2 - General Fault State	On	Normal	

Figure 6-11 Multi-purpose interface card showing the outputs.

There is a record for each of the 2 outputs, showing the output type, allocated zone number, descriptor, state and status.

6.3.4 Multi-purpose output card

The multi-purpose output card has 8 outputs, and outputs can be formed into pairs. (refer to section 4.2.5.2). The status screen for the Multi-purpose output card shows the modules status and the status of the outputs as follows:





MODULE						
Type	Location			Sw. Version	Hw. Version	Status
MOC	N1	R1	S3	01.00.06	15.15.255	Fault
Number	Zone	Description		State	Status	Action
1	1	Output 1		Off	Normal	
3	2	Output 3		Off	Normal	
5	3	Output 5 - Single Ended (Alert)		Off	Open Circuit	
6	3	Output 6 - Single Ended (Evac)		Off	Normal	
7	4	Output 7 - Single Ended (Alert)		Off	Open Circuit	
8	4	Output 8 - Single Ended (Evac)		Off	Normal	

Figure 6-12 Multi-purpose output card status screen

In the above screen:

- Output 1 and 2 are a pair – creating a polarity reversal output (2 wire dual strobes)
- Output 3 and 4 are a pair.
- Output 5 single output
- Output 6 single output
- Output 7 single output
- Output 8 single output

The following explains the content of the screen.

	Display the previous module in the node
	Display the next module in the node

Type	Location	Sw. Version	Hw. Version	Status
MOC	N1 R1 S3	01.00.06	15.15.255	Fault

Figure 6-13 Multi-purpose output card status

Above is the module type “MOC”, location – Node 1, Rack 1, Slot 3, Software version 01.00.06, hardware version 15.15.255 and status is in Fault.

Number	Zone	Description	State	Status	Action
1	1	Output 1	Off	Normal	

Figure 6-14 Output status

There is a record for each of the outputs, showing the output type as analogue, allocated zone number, description, state and status.

6.3.5 Quad radial EIS line card (ILC)

The Quad radial EIS line card (also known as the ILC) intercommunication Line card supports 4 handsets with each handset supporting an input (which is normally interfaced to an MCP), refer to section 4.2.5.7. The default status screen for the Quad radial EIS line card shows the modules status and the status of the 4 handsets as follows:

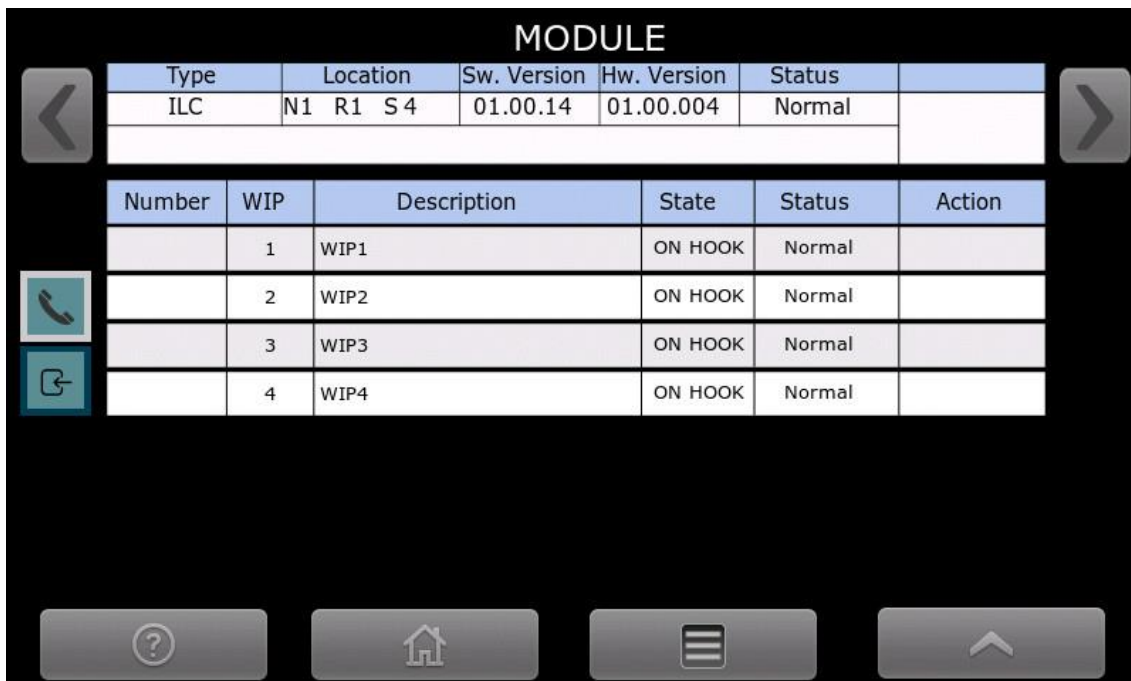





Figure 6-15 Quad radial EIS line card status screen

The following explains the content of the screen.

	Display the previous module in the node
	Display the next module in the node
	Display the status of the handsets – handsets are currently displayed as the icon is highlighted
	Press to display the inputs. Each handset supports one input

Type	Location	Sw. Version	Hw. Version	Status
ILC	N1 R1 S 4	01.00.14	01.00.004	Normal

Figure 6-16 Quad radial EIS line card status

Above is the module type “ILC”, location – Node 1, Rack 1, Slot 4, Software version 01.00.14, hardware version 01.00.004 and status is Normal.

Number	WIP	Description	State	Status	Action
	1	WIP1	ON HOOK	Normal	

Figure 6-17 Handset status

There is a record for each of the handsets, showing the type as WIP, allocated zone number, description, state and status.

Figure 6-18 shows the quad radial EIS line card status, and as the  is highlighted, the inputs are displayed.

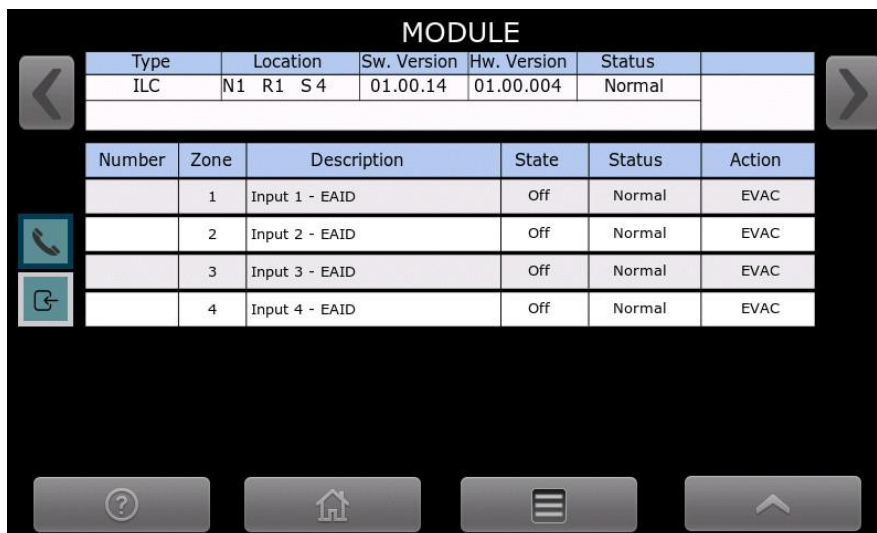

MODULE						
Type	Location			Sw. Version	Hw. Version	Status
ILC	N1	R1	S 4	01.00.14	01.00.004	Normal
Number	Zone	Description		State	Status	Action
	1	Input 1 - EAID		Off	Normal	EVAC
	2	Input 2 - EAID		Off	Normal	EVAC
	3	Input 3 - EAID		Off	Normal	EVAC
	4	Input 4 - EAID		Off	Normal	EVAC

Figure 6-18 Quad radial EIS card status showing the inputs.

There are four inputs (one associated with each handset), and the inputs are digital, assigned to a zone, have a description, state and status.

6.3.6 Dual loop EIS line card (LILC)

The Dual loop EIS line card (aka LILC Loop Interface Line Card) supports 2 fault tolerant (redundant) loops, with each loop supporting up to 20 WIP handsets. Each handset supports an input (which is normally interfaced to an MCP), refer to section 4.2.5.8. The default status screen for the Dual loop EIS line card shows the modules status and the status of the configured handsets as follows:

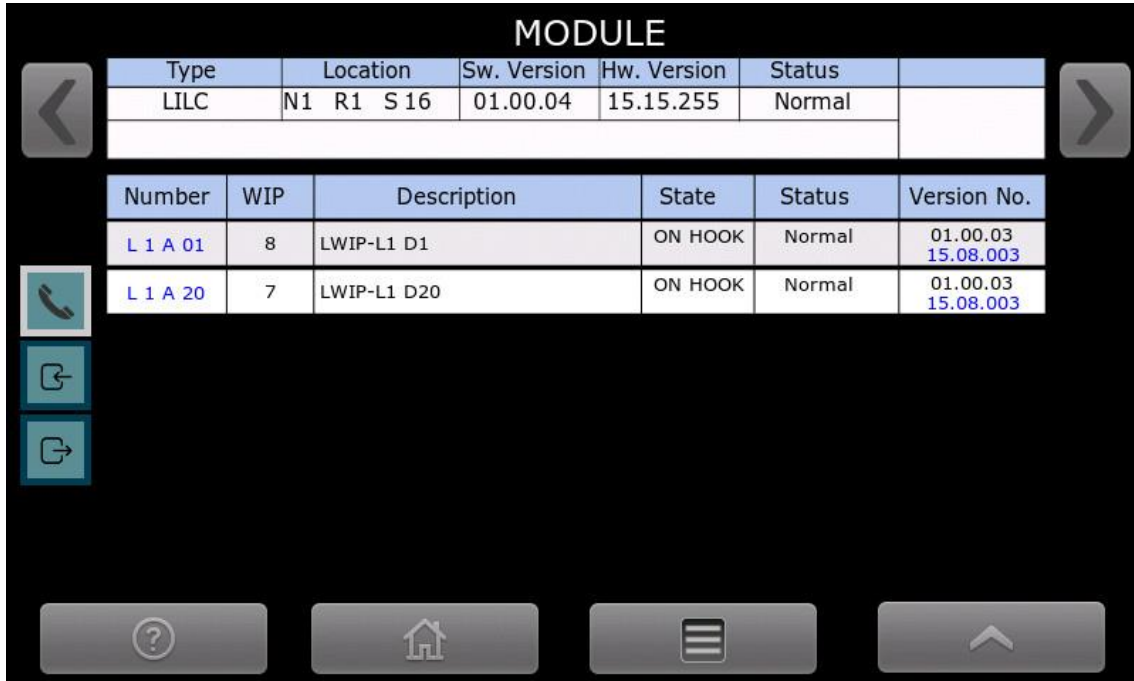







Figure 6-19 Dual loop EIS line card status screen

The following explains the content of the screen.

	Display the previous module in the node
	Display the next module in the node
	Display the status of the handsets – handsets are currently displayed as the icon is highlighted
	Press to display the inputs. Each handset supports one input
	Press to display the status of the loop outputs. Four outputs are support – Port 1 - loop 1 out, Port 2 - loop 1 in, Port 3 - loop 2 out and Port 4 - loop 2 in

Type	Location	Sw. Version	Hw. Version	Status
LILC	N1 R1 S 16	01.00.04	15.15.255	Normal

Figure 6-20 Dual loop EIS line card status

Above is the module type “LILC” Loop Intercom Line Card, Location is Node 1, Rack 1, Slot 16, Software Version 01.00.04 and hardware version 15.15.255, status is normal.

Number	WIP	Description	State	Status	Version No.
L 1 A 01	8	LWIP-L1 D1	ON HOOK	Normal	01.00.03 15.08.003

Figure 6-21 Handset status

Above is the address of WIP handset – Loop 1 (of 2), Address is 01 (of 20) – on the loop, reference WIP handset number is 8, assigned descriptor, state is ON HOOK, status is normal, and the software version is 01.00.03 and hardware version (in blue) is 15.08.003

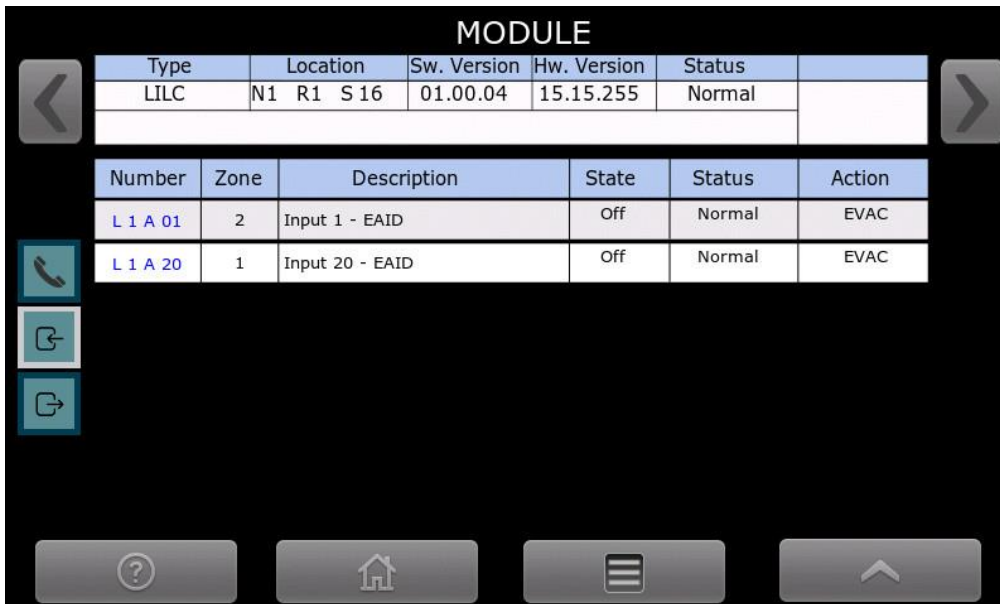

The screenshot shows a mobile application interface titled "MODULE". It displays a table with the following data:

Type	Location	Sw. Version	Hw. Version	Status
LILC	N1 R1 S 16	01.00.04	15.15.255	Normal

Number	Zone	Description	State	Status	Action
L 1 A 01	2	Input 1 - EAID	Off	Normal	EVAC
L 1 A 20	1	Input 20 - EAID	Off	Normal	EVAC

The interface also includes navigation icons (back, forward, home, search, list, up) and a sidebar with a phone icon and two square icons, one of which is highlighted with a red box.

Figure 6-22 Dual loop EIS line card input status screen

Above is status the inputs associated with the WIP handsets – since the  icon is highlighted. With the first entry:

- Location is loop 1 (of 2), address is 01 (of 20) – on the loop.
- Assigned to emergency warning zone 2.
- User assigned descriptor.
- State is Off
- Status is Normal
- Assigned action type is Evac.

MODULE						
Type	Location			Sw. Version	Hw. Version	Status
LILC	N1	R1	S 16	00.00.01	15.15.255	Normal

Port	Loop	Description	State	Status	Break Addr.
1	1	N/A	Active	Normal	
2	1	N/A	Inactive	Normal	
3	2	N/A	Inactive	Normal	
4	2	N/A	Inactive	Normal	

Figure 6-23 Dual loop EIS line card output status screen

Above is the status of the loop outputs – since the  icon is highlighted.

Port 1 and 2 relate to loop 1 – and the state shows the loop is driving out of Port 1 only, status is Normal.

Port 3 and 4 relate to loop 2 – and the state shows both ports are inactive – meaning the loop is inactive. From Figure 6-19 – there are no phones configured on the second loop.

For the loop status to be normal, the loop has no faults and only Port 1 (or 3) will be active.

If the loop has an interruption – then the loop status will be open circuit, and port 1 (or 3) and 2 (or 4) will be driving.

If the loop has a short circuit, then the transmission path isolators contained within the phones located at the short circuit will be activated – and isolate the short-circuited piece of cable – creating an interruption. Port 1 (or 2) and 3 (or 4) will be driving.

6.3.7 Dual 25-watt amplifier card

The Dual 25-watt amplifier card supports 2x25 watt amplifiers, refer to section 4.2.5.4. The status screen for the Dual 25-watt amplifier card shows the modules status and the status of the 2 amplifiers as follows:

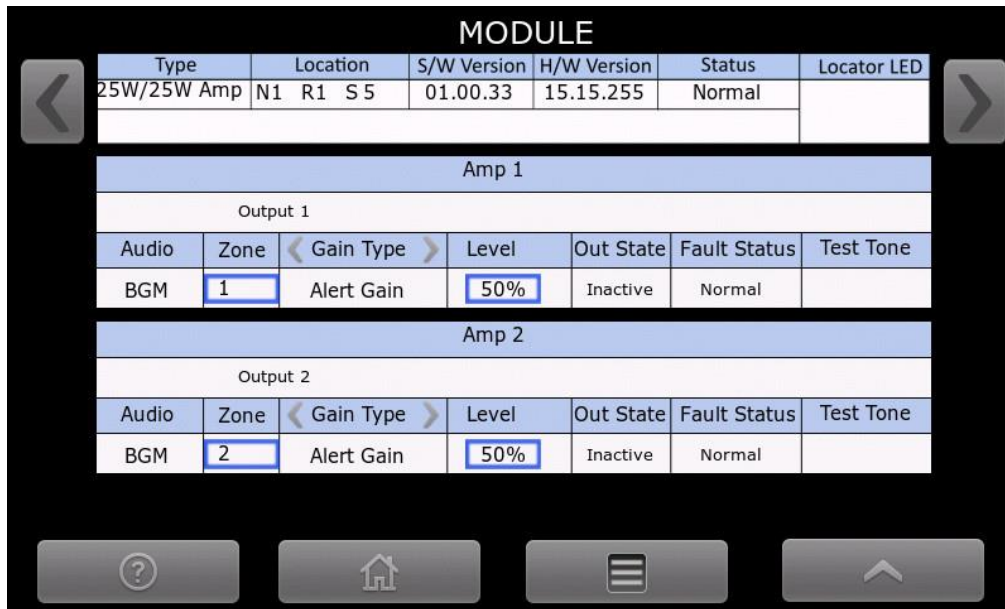



Figure 6-24 Dual 25-watt amplifier card status screen

The following explains the content of the screen.

	Display the previous module in the node
	Display the next module in the node

Type	Location			S/W Version	H/W Version	Status	Locator LED
25W/25W Amp	N1	R1	S 5	01.00.33	15.15.255	Normal	

Figure 6-25 Dual 25-watt amplifier card status

Above is the module type “25W/25W Amp”, location – Node 1, Rack 1, Slot 5, Software version 01.00.33, hardware version 15.15.255 and status is Normal.

Amp 1						
Output 1						
Audio	Zone	Gain Type	Level	Out State	Fault Status	Test Tone
BGM	1	Alert Gain	50%	Inactive	Normal	

Figure 6-26 Amplifier status

Above is the amplifier status. The top field (“Output 1”) is the descriptor. The Audio field shows that this amplifier has BGM assigned. The zone number assigned to the amplifier is shown, and the 1 denotes that the zone number is editable (at access level 3 – see 6.2). The Gain Type and Level show the relative volume setting for each of the assigned audio streams. Press the > and < to cycle thru the audio streams (Alert Gain, Evac Gain, Alarm Gain, BGM Gain, PA Gain, Paging Gain, Custom Gain 1, Custom Gain2). To edit the level, access level 3 is required (see 6.2).

6.3.8 50Watt amplifier card

The 50-watt amplifier card supports 1x50 watt amplifier, refer to section 4.2.5.5. The status screen for the 50-watt amplifier card shows the modules status and the status of the amplifier as follows:

MODULE						
Type	Location	S/W Version	H/W Version	Status	Locator LED	
50W Amp	N1 R1 S 7	01.00.33	15.15.255	Normal		

Amp 1						
Output 1						
Audio	Zone	Gain Type	Level	Out State	Fault Status	Test Tone
BGM	3	Alert Gain	50%	Inactive	Normal	

Figure 6-27 50-watt amplifier card status screen

6.3.9 150-Watt Amplifier Card

150-watt amplifier card supports one 150W Emergency Warning zone. Refer to section 4.2.5.6.

Provides Potential for four separate **paging zones** when an RPC is installed, and outputs are configured & wired accordingly. The status screen for the 150-watt amplifier card shows the module status and the status of the amplifier as follows:

MODULE							
Type	Location			Sw. Version	Hw. Version	Status	
150W Amp	N1	R1	S 15	01.00.09	15.15.255	Normal	
Amp 1							
Output 1							
Audio	Zone	Gain Type		Level	Out State	Fault Status	Test Tone
BGM	9	Alert Gain		50%	Off	Normal	
BGM	9	Output 2			Off	Normal	
BGM	9	Output 3			Off	Normal	
BGM	9	Output 4			Off	Normal	

Figure 6-28 150W amplifier status screen

6.3.10 Public Address Interface Card PAIC

The status screen for the PAIC shows the modules status as follows:

MODULE						
Type	Location			Sw. Version	Hw. Version	Status
PAIC - BOSCH	N1	R1	S 2	01.00.07	15.15.255	Normal
Public Address Interface Card						

Figure 6-29 PAIC status screen

6.3.11 Graphical user interface

The graphical user interface card supports the touch screen and has 4 digital inputs. The status screen is as follows:

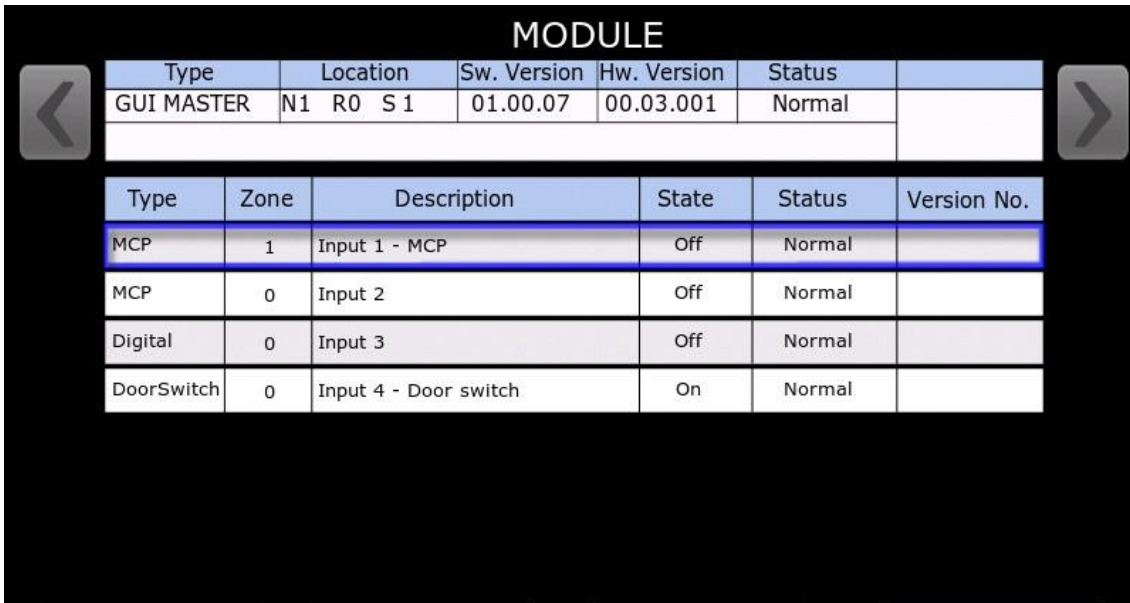



Type	Location	Sw. Version	Hw. Version	Status
GUI MASTER	N1 R0 S 1	01.00.07	00.03.001	Normal

Type	Zone	Description	State	Status	Version No.
MCP	1	Input 1 - MCP	Off	Normal	
MCP	0	Input 2	Off	Normal	
Digital	0	Input 3	Off	Normal	
DoorSwitch	0	Input 4 - Door switch	On	Normal	

Figure 6-30 Graphical user interface status screen

The following explains the content of the screen.

	Display the previous module in the node
	Display the next module in the node

Type	Location	Sw. Version	Hw. Version	Status
GUI MASTER	N1 R0 S 1	01.00.07	00.03.001	Normal

Figure 6-31 Graphical user interface status

From above is the module type “GUI PRIMARY”, location – Node 1, Rack 0, Slot 1, Software version 01.00.07, hardware version 00.03.001 and status is Normal.

The input status is the same as the Multi-purpose interface card, refer to section 6.3.3

The first Graphical user interface fitted to a cabinet is the Primary, and any other Graphical user interfaces fitted are referred to as Secondaries. The secondaries do not have the inputs fitted and their Type is GUI SECONDARY.

6.3.12 Power supply

Refer to section 4.2.2 for detailed information on the function and configuration of the power supply.

Figure 6-30 is the status screen for the power supply.

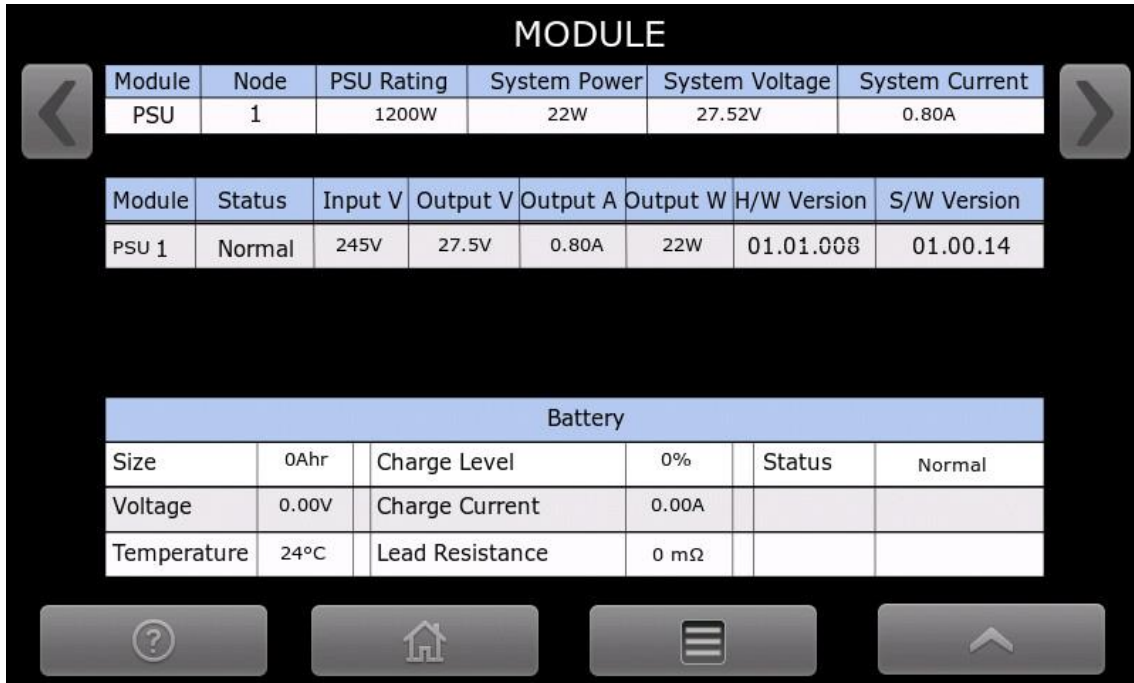



Figure 6-32 Power supply status screen

The following explains the content of the screen.

	Display the previous module in the node
	Display the next module in the node

Module	Node	PSU Rating	System Power	System Voltage	System Current
PSU	1	1200W	22W	27.52V	0.80A

Figure 6-33 Power supply status

Figure 6-31 details the overall power status of the cabinet. The node number, PSU rating, current system power, current system voltage and system current is displayed.

Module	Status	Input V	Output V	Output A	Output W	H/W Version	S/W Version
PSU 1	Normal	245V	27.5V	0.80A	22W	01.01.008	01.00.14

Figure 6-34 Power supply module status

Figure 6-32 details the status of each of the fitted power supply modules (24U cabinet supports up to 3 modules and the 13U cabinet supports up to 2 modules).

The status, input voltage, output voltage, output current, output power and software and hardware version of the Power control card is displayed.







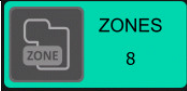

Battery					
Size	0Ahr	Charge Level	0%	Status	Normal
Voltage	0.00V	Charge Current	0.00A		
Temperature	24°C	Lead Resistance	0 mΩ		

Figure 6-35 Battery status

Figure 6-33 details the status of the connected batteries, detailing size, voltage, temperature, charge level, charge current and lead resistance.

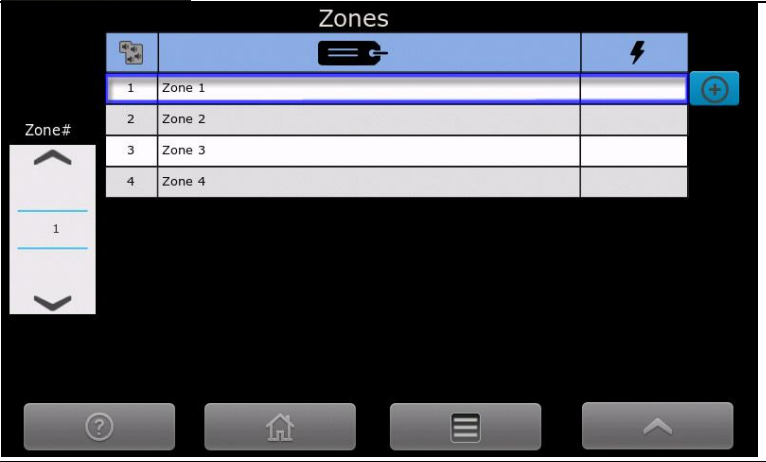

6.4 Zones

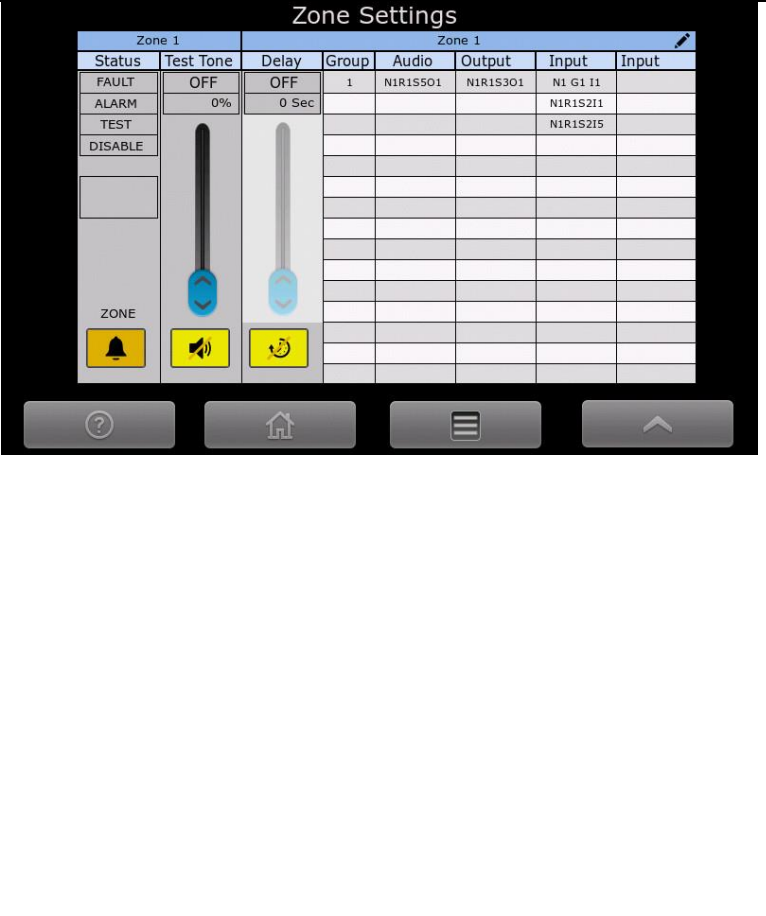
To access the Zones screen, the following controls are activated.

1 Menu control	
2 Zone control	
3 Zones Screen Shows a list of zones configured in the system. If there are any faults on a node, there will be  in the  column. Activate the  control for detail on the zone.	
4 Individual Zone Screen Shows the status and configuration of the zone. The  control is used to disable / enable the zone. The  control is used to turn on and off the test tone for the zone. The volume of the test tone is set by the associated slider control. The  control is used to enable a delay on the zone entering the emergency warning condition. The duration of the delay is set by the slider control. Refer to section 5.4.3.1 for further detail on delays. The  control allows the zone descriptor to be changed.	







There are two zone descriptors – a short and long. The short descriptor is displayed above the Status and Test Tone fields and is used in the individual EWS controls and indicators. Refer to section 5.1.12.

The long descriptor is displayed in the logs.

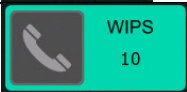
To edit the short and long descriptor, activate the , (you will be prompted for access level 3 user ID and password), then activate the  again. A keyboard will appear to allow the descriptors to be edited.



6.5 WIPs

To access the WIP screen, the following controls are activated.

1	Menu control																																													
2	WIP control																																													
3	<p>WIP Screen</p> <p>Shows a list of WIP handsets configured in the system.</p> <p>If there are any faults on WIP node, there will be a  in the  column.</p> <p>The  control allows the WIP handset descriptor to be changed.</p> <p>The  column gives the physical location of the handset connection to the system, Node Rack Slot input.</p>	 <table border="1" data-bbox="778 824 1366 1176"> <thead> <tr> <th>WIP#</th> <th>Handset Name</th> <th>Status</th> <th>Location</th> </tr> </thead> <tbody> <tr><td>1</td><td>WIP 1</td><td></td><td>N1 R1 S4 I 1</td></tr> <tr><td>2</td><td>WIP 2</td><td></td><td>N1 R1 S4 I 2</td></tr> <tr><td>3</td><td>WIP 3</td><td></td><td>N1 R1 S4 I 3</td></tr> <tr><td>4</td><td>WIP 4</td><td></td><td>N1 R1 S4 I 4</td></tr> <tr><td>5</td><td>WIP 5</td><td></td><td>N2 R1 S4 I 1</td></tr> <tr><td>6</td><td>WIP 6</td><td></td><td>N2 R1 S4 I 2</td></tr> <tr><td>7</td><td>WIP 7</td><td></td><td>N2 R1 S4 I 3</td></tr> <tr><td>8</td><td>WIP 8</td><td></td><td>N2 R1 S4 I 4</td></tr> <tr><td>9</td><td>WIP 9-N1 M.WIP</td><td></td><td>N1 R1 S0 I 0</td></tr> <tr><td>10</td><td>WIP 10-N2 M.WIP</td><td></td><td>N2 R1 S0 I 0</td></tr> </tbody> </table>	WIP#	Handset Name	Status	Location	1	WIP 1		N1 R1 S4 I 1	2	WIP 2		N1 R1 S4 I 2	3	WIP 3		N1 R1 S4 I 3	4	WIP 4		N1 R1 S4 I 4	5	WIP 5		N2 R1 S4 I 1	6	WIP 6		N2 R1 S4 I 2	7	WIP 7		N2 R1 S4 I 3	8	WIP 8		N2 R1 S4 I 4	9	WIP 9-N1 M.WIP		N1 R1 S0 I 0	10	WIP 10-N2 M.WIP		N2 R1 S0 I 0
WIP#	Handset Name	Status	Location																																											
1	WIP 1		N1 R1 S4 I 1																																											
2	WIP 2		N1 R1 S4 I 2																																											
3	WIP 3		N1 R1 S4 I 3																																											
4	WIP 4		N1 R1 S4 I 4																																											
5	WIP 5		N2 R1 S4 I 1																																											
6	WIP 6		N2 R1 S4 I 2																																											
7	WIP 7		N2 R1 S4 I 3																																											
8	WIP 8		N2 R1 S4 I 4																																											
9	WIP 9-N1 M.WIP		N1 R1 S0 I 0																																											
10	WIP 10-N2 M.WIP		N2 R1 S0 I 0																																											







There are two WIP handset descriptors – a short and long. The short descriptor is used in the individual EIS controls and indicators. Refer to section 5.1.13.

The long descriptor is displayed in the logs.

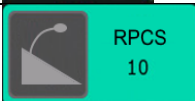

To edit the short and long descriptor, activate the , (you will be prompted for access level 3 user ID and password), then activate the  again. A keyboard will appear to allow the descriptors to be edited.

6.6 Remote Paging Consoles

To access the RPC screen, the following controls are activated.

1	Menu control																																																								
2	RPC controls																																																								
3	<p>RPC Screen</p> <p>Shows the list of RPCs configured in the system.</p> <p>If there are any faults on RPC node, there will be a  in the  column.</p> <p>The  control allows the RPC descriptor to be changed.</p> <p>The  column gives the Node DCPU number and the RPC address number.</p>	 <table border="1" data-bbox="775 584 1366 1066"> <caption>RPCS</caption> <thead> <tr> <th>RPC#</th> <th>Descriptions</th> <th>Status</th> <th>Node DCPU</th> <th>RPC Address</th> </tr> </thead> <tbody> <tr> <td>1</td> <td>Descriptions</td> <td>Normal</td> <td>N1</td> <td>R1</td> </tr> <tr> <td>2</td> <td></td> <td>Normal</td> <td>N1</td> <td>R2</td> </tr> <tr> <td>3</td> <td></td> <td>Normal</td> <td>N1</td> <td>R3</td> </tr> <tr> <td>4</td> <td></td> <td>Fault</td> <td>N1</td> <td>R4</td> </tr> <tr> <td>5</td> <td></td> <td>Normal</td> <td>N2</td> <td>R1</td> </tr> <tr> <td>6</td> <td></td> <td>Missing</td> <td>N2</td> <td>R2</td> </tr> <tr> <td>7</td> <td></td> <td>Normal</td> <td>N2</td> <td>R3</td> </tr> <tr> <td>8</td> <td></td> <td></td> <td></td> <td></td> </tr> <tr> <td>9</td> <td></td> <td></td> <td></td> <td></td> </tr> <tr> <td>10</td> <td></td> <td></td> <td></td> <td></td> </tr> </tbody> </table>	RPC#	Descriptions	Status	Node DCPU	RPC Address	1	Descriptions	Normal	N1	R1	2		Normal	N1	R2	3		Normal	N1	R3	4		Fault	N1	R4	5		Normal	N2	R1	6		Missing	N2	R2	7		Normal	N2	R3	8					9					10				
RPC#	Descriptions	Status	Node DCPU	RPC Address																																																					
1	Descriptions	Normal	N1	R1																																																					
2		Normal	N1	R2																																																					
3		Normal	N1	R3																																																					
4		Fault	N1	R4																																																					
5		Normal	N2	R1																																																					
6		Missing	N2	R2																																																					
7		Normal	N2	R3																																																					
8																																																									
9																																																									
10																																																									





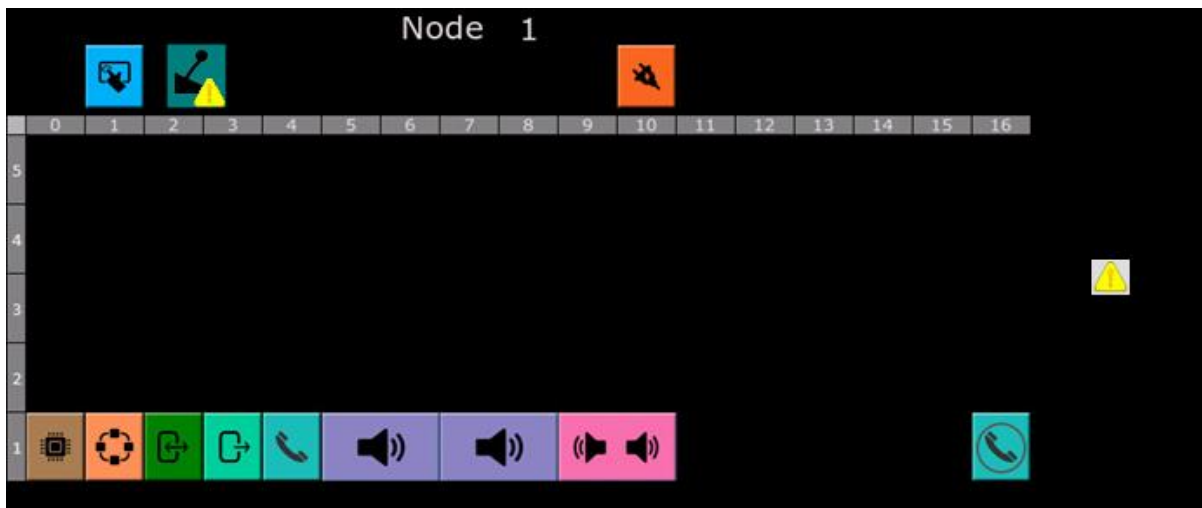

The RPC descriptor can be set or edited for each unit.

To edit the descriptor, activate the , (you will be prompted for access level 3 user ID and password), then activate the  again. A keyboard will appear to allow the descriptors to be edited.







Also view RPCs from the Node screen **Section 6.3** (Shown in Fault condition).





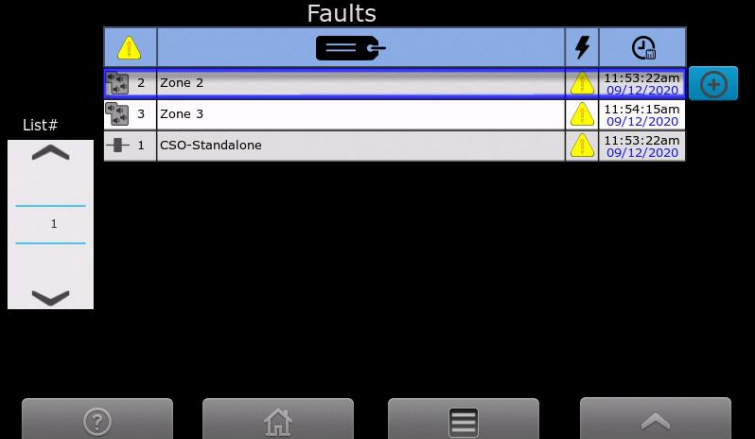

6.7 Alarms

1	Menu control	
2	Alarm control – only if there is at least one alarm present. Control shows 1 alarm condition	
3	<p>Alarm Screen</p> <p>Shows a list of alarms.</p> <p>The  column zones the zone number in alarm.</p> <p>The  in the  column indicates an alarm.</p> <p>The  column shows the date / time of the alarm.</p>	



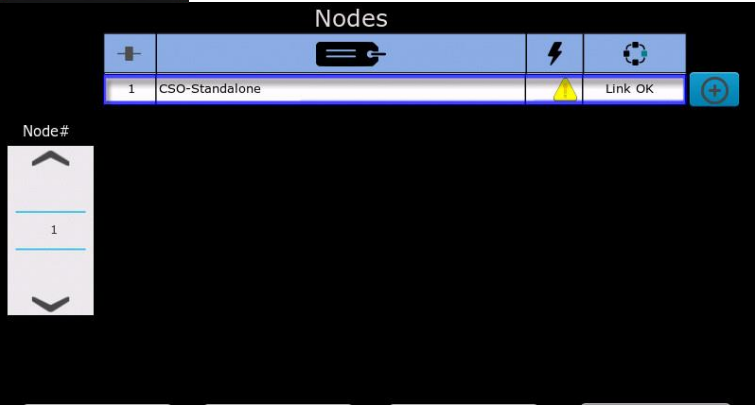

6.8 Faults

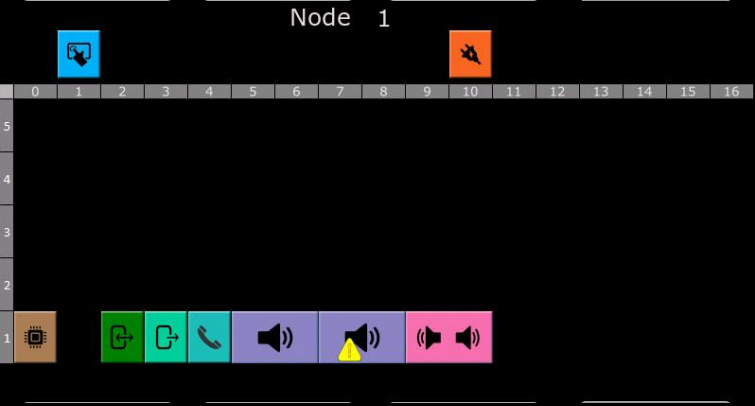
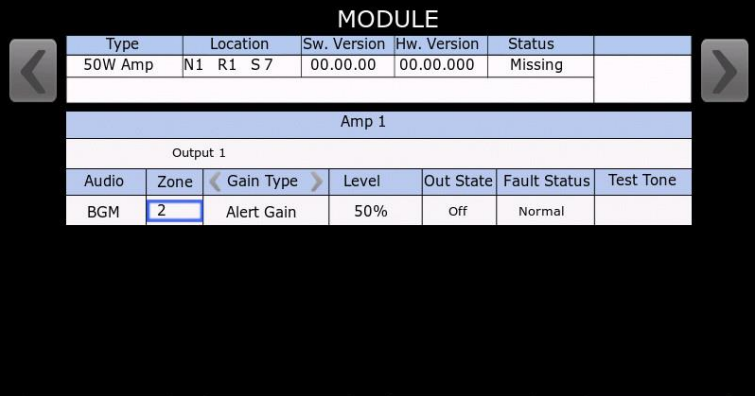
<p>1 Menu control</p>	
<p>2 Fault control – only if there is at least one fault present. Control shows 3 faults conditions</p>	
<p>3 Fault Screen</p> <p>Shows a list of faults.</p> <p>The  in the  column indicates a fault.</p> <p>The  control will provide detail on the individual fault.</p>	
<p>4 Zone 2 Fault Detail</p> <p>Shows the detail for zone 2, and the audio output is in fault.</p>	
<p>5 Zone 3 Fault Detail</p> <p>Shows the detail for zone 3, and the audio output is in fault.</p>	

The faults can also be viewed in the NODE screen.



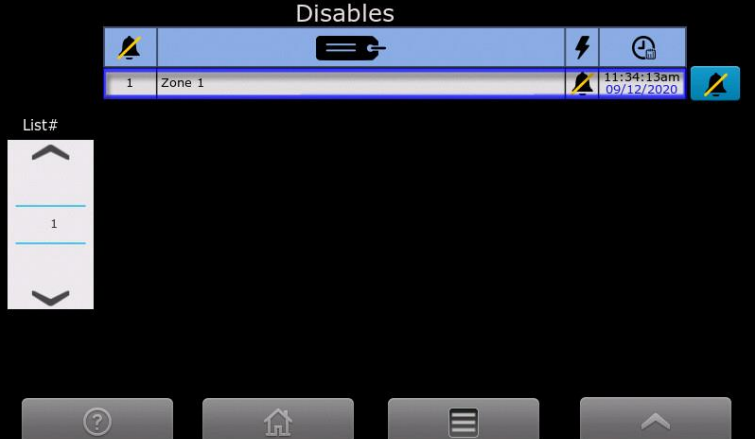

1	Menu control																																																		
2	Node's control																																																		
3	<p>List of Node screen</p> <p>The  associated with node 1, shows the fault is on Node 1</p>																																																		
4	<p>Node 1 Screen</p> <p>The  shows there is a fault on the 50watt amplifier in slot 7/8</p>																																																		
5	<p>Amplifier status screen</p> <p>From the status screen – the status of the module is missing</p>	 <table border="1" data-bbox="646 1310 1276 1512"> <thead> <tr> <th colspan="7">MODULE</th> </tr> <tr> <th>Type</th> <th colspan="3">Location</th> <th>Sw. Version</th> <th>Hw. Version</th> <th>Status</th> </tr> </thead> <tbody> <tr> <td>50W Amp</td> <td>N1</td> <td>R1</td> <td>S7</td> <td>00.00.00</td> <td>00.00.000</td> <td>Missing</td> </tr> </tbody> </table> <table border="1" data-bbox="646 1400 1276 1512"> <thead> <tr> <th colspan="7">Amp 1</th> </tr> <tr> <th colspan="7">Output 1</th> </tr> <tr> <th>Audio</th> <th>Zone</th> <th>Gain Type</th> <th>Level</th> <th>Out State</th> <th>Fault Status</th> <th>Test Tone</th> </tr> </thead> <tbody> <tr> <td>BGM</td> <td>2</td> <td>Alert Gain</td> <td>50%</td> <td>Off</td> <td>Normal</td> <td></td> </tr> </tbody> </table>	MODULE							Type	Location			Sw. Version	Hw. Version	Status	50W Amp	N1	R1	S7	00.00.00	00.00.000	Missing	Amp 1							Output 1							Audio	Zone	Gain Type	Level	Out State	Fault Status	Test Tone	BGM	2	Alert Gain	50%	Off	Normal	
MODULE																																																			
Type	Location			Sw. Version	Hw. Version	Status																																													
50W Amp	N1	R1	S7	00.00.00	00.00.000	Missing																																													
Amp 1																																																			
Output 1																																																			
Audio	Zone	Gain Type	Level	Out State	Fault Status	Test Tone																																													
BGM	2	Alert Gain	50%	Off	Normal																																														

6.9 Disables

<p>1 Menu control</p>	
<p>2 Disables control – only if there is at least one emergency zone disable. Control shows 1 disable condition</p>	
<p>3 Disable Screen</p> <p>Shows a list of zones that are disabled, with a date and time tag.</p>  <p>The  control will toggle the disabled state.</p>	

6.10 Logs

To access the Logs screen, the following controls are activated.

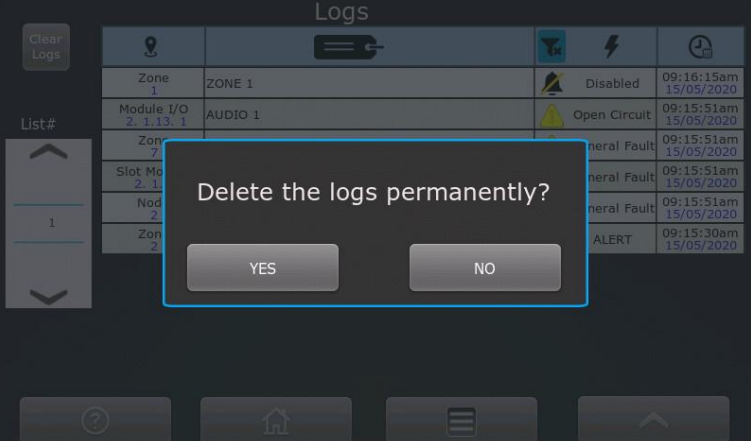
1 Menu control	
2 Log control	
3 Logs Screen Shows a list of events that have occurred in the system.  The  control clears the logs.	
4 Clearing the logs Prompted to confirm clearing the logs	

6.11 Date and Time



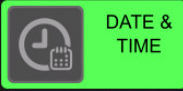
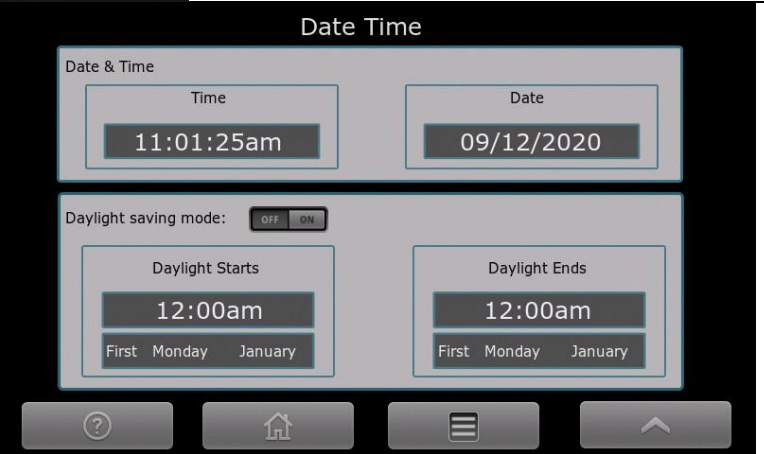
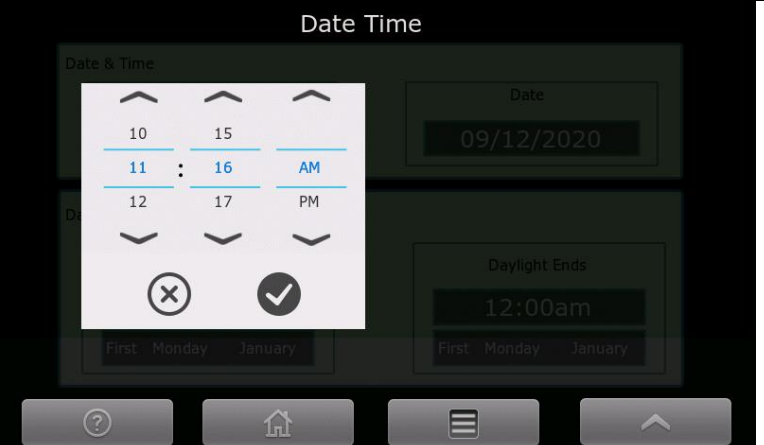

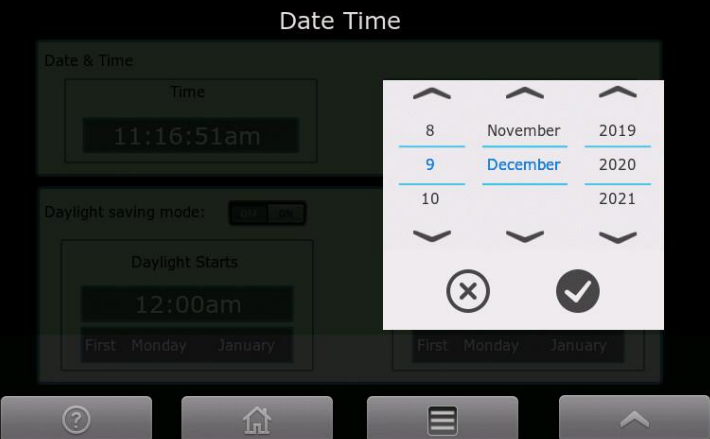
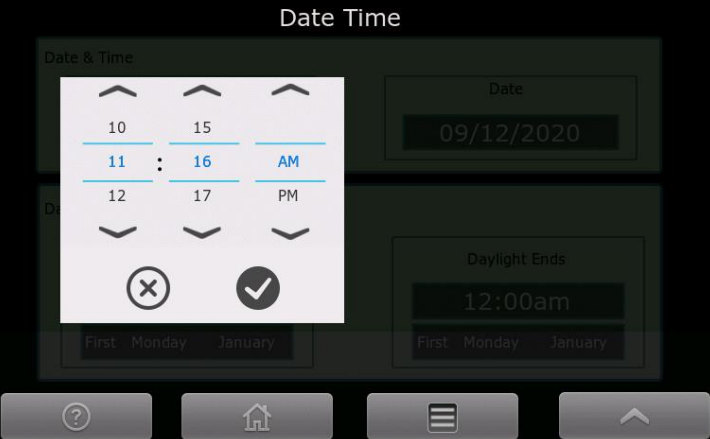
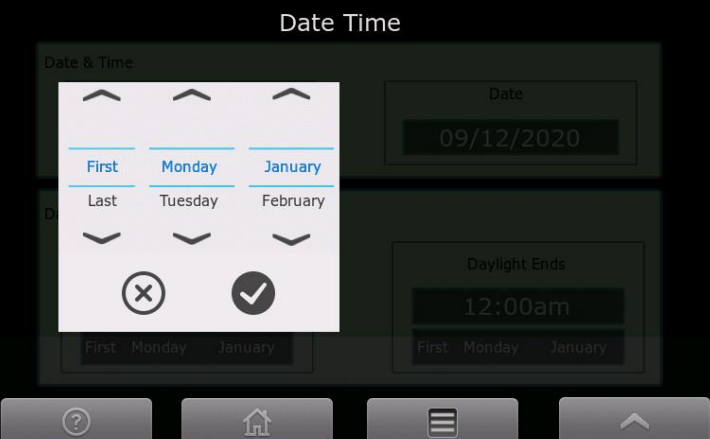

To set the date and time, the following controls are activated.





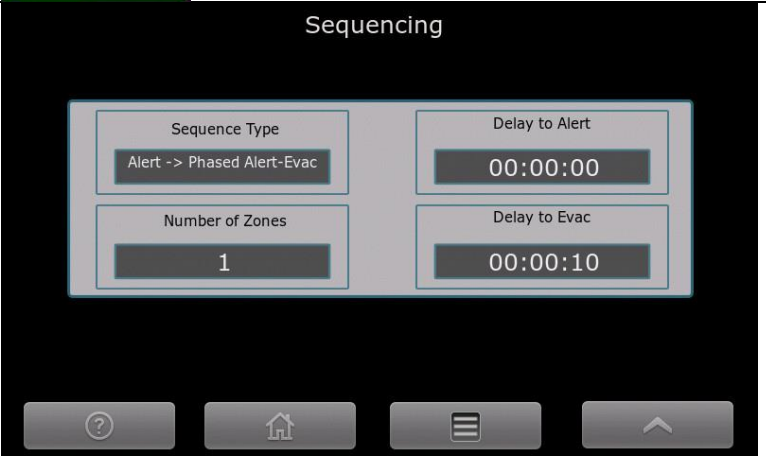
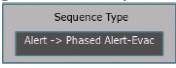



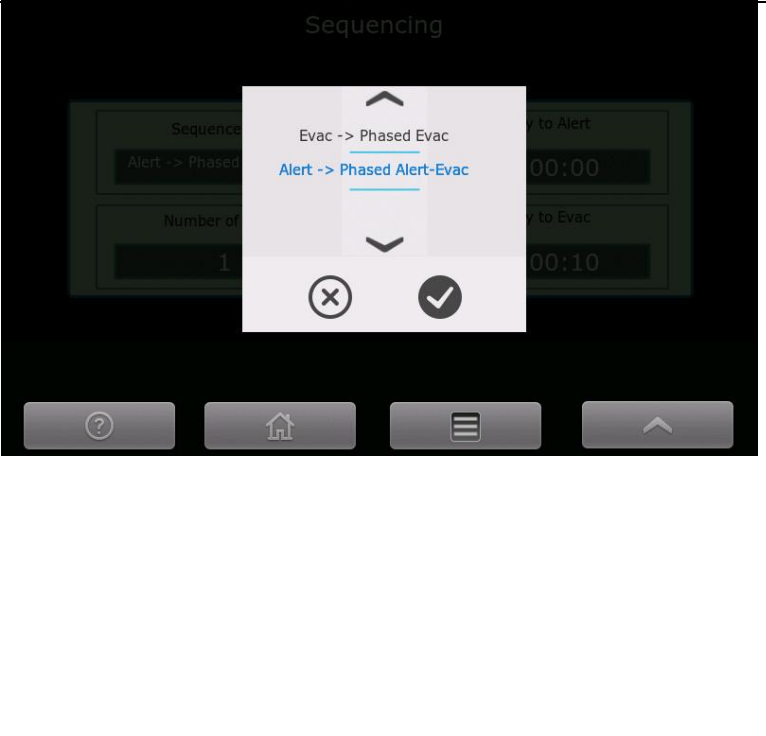

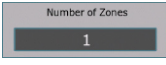

1	Menu control	
2	Date and time control (require access level 3)	
3	<p>Date and Time Screen</p> <p>Shows the current date and time, and daylight-saving details.</p> <p>To set the time, select the 11:01:25am control.</p> <p>To set the date, select the 09/12/2020 control.</p> <p>To turn daylight saving on / off, select the OFF ON control.</p> <p>To set the daylight-saving start/end time, select the 12:00am control.</p> <p>To set the daylight-saving start/end date, select the First Monday January control.</p>	
4	Setting the Time	

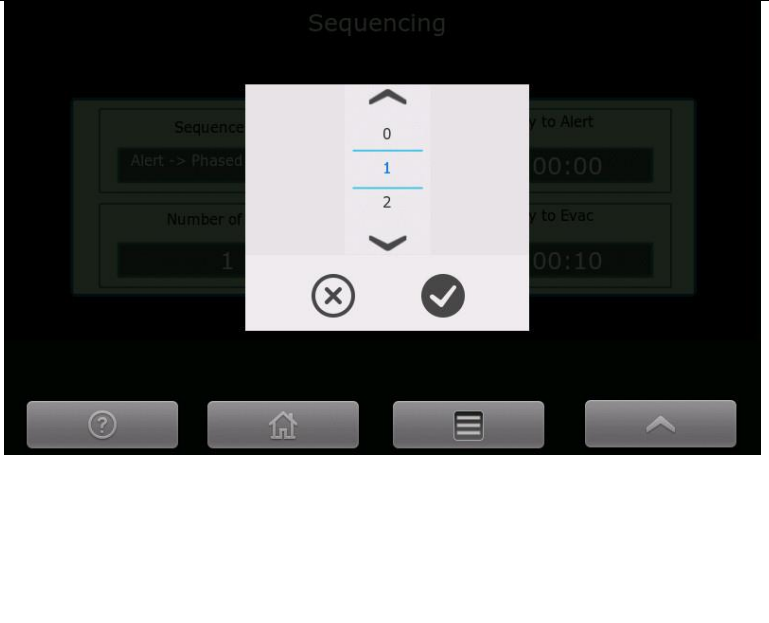
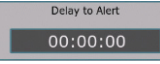
<p>5 Setting the Date</p>	
<p>6 Setting daylight saving start or end time</p>	
<p>7 Setting the daylight-saving start or end day</p>	

6.12 Sequencing

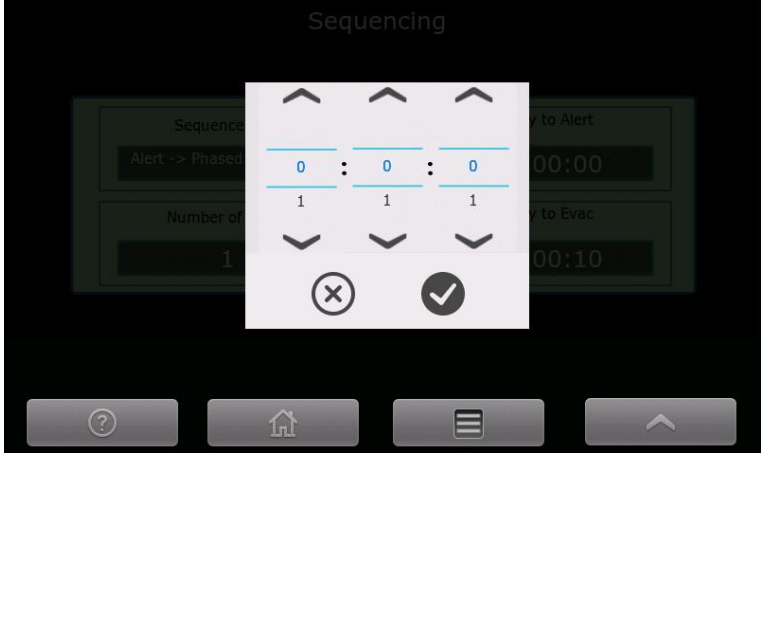
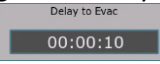
To edit the sequencing, refer to the following steps.

1	Menu control	
2	Sequencing control (requires access level 3)	
3	<p>Sequence Screen</p> <p>Shows the sequence type, the number of zones, delay to alert and delay to evac.</p> <p>The number of zones, delay to alert and delay to evac are all parameters to the sequence type.</p>	
4	<p>Sequence type screen.</p> <p>To set/change the sequence type – activate the  control.</p> <p>The  and  controls step thru the available sequences.</p> <p>The  cancels the action</p> <p>The  accepts the selected sequence.</p> <p>Refer to the Sequencing Table in this section (6.11) for further detail on the sequence.</p>	

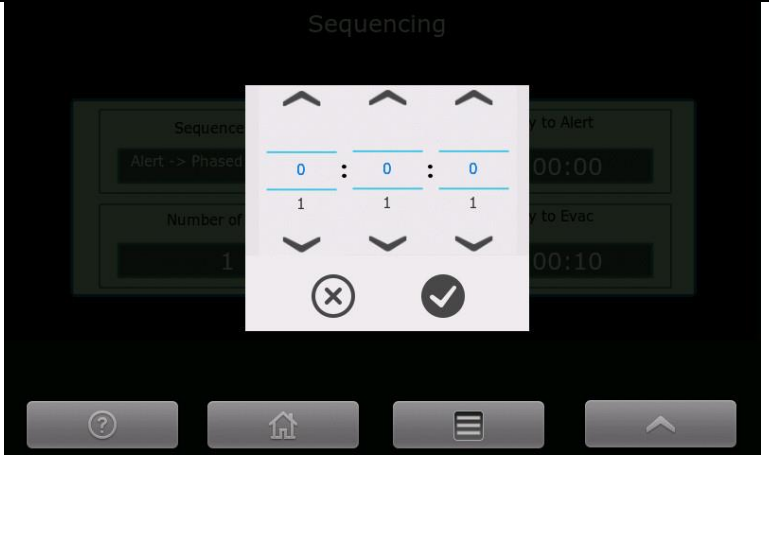
<p>5 Number of zones screen</p> <p>To set/change the number of zones – activate the  control.</p> <p>The  and  controls step thru the number of emergency zones</p> <p>The  cancels the action</p> <p>The  accepts the selected number of emergency zones</p>	
<p>6 Delay to alert screen</p> <p>To set/change the delay to alert – activate the  control.</p> <p>The  and  controls step thru the hours, minutes and seconds</p> <p>The  cancels the action</p> <p>The  accepts the displayed delay to alert.</p>	
<p>7 Delay to evac screen</p> <p>To set/change the delay to evac – activate the  control.</p> <p>The  and  controls step thru the hours, minutes and seconds</p> <p>The  cancels the action</p> <p>The  accepts the displayed delay to evac.</p>	

The sequencing controls determines how the EWS reacts to an alarm signal.

Alarm signals can be programmed to generate an alert event type or an evacuate event type (in the context of sequencing)

Sequencing Table

Sequence	Trigger Condition	Description
Alert -> All Alert	Alert	If any alarm signal configured as type Alert is activated, then all configured emergency zones broadcast the alert signal after the <i>Delay to Alert</i> timeout has expired
Alert -> All Evac	Alert	If any alarm signal configured as type Alert is activated, then all configured emergency zones broadcast the evacuate signal after the <i>Delay to Evac</i> timeout has expired.
Evac -> All Evac	Evac	If any alarm signal configured as type Evac is activated, then all configured emergency zones broadcast the evacuate signal after the <i>Delay to Evac</i> timeout has expired.
Alert ->Phased Alert	Alert	When an alarm signal assigned to an emergency zone and configured as type Alert is activated, the associated emergency zone broadcasts the alert signal (after the <i>Delay to Alert</i> timeout has expired). After the broadcast has commenced, the next <i>Number of Zones</i> and the previous <i>Number of Zones</i> broadcast the alert signal (after the <i>Delay to Alert</i> timeout has expired). This continues until all zones are broadcasting the alert signal.
Evac ->Phased Evac	Evac	When an alarm signal assigned to an emergency zone and configured as type Evac is activated, the associated emergency zone broadcasts the evac signal (after the <i>Delay to Evac</i> timeout has expired). After the broadcast has commenced, the next <i>Number of Zones</i> and the previous <i>Number of Zones</i> broadcast the evac signal (after the <i>Delay to Evac</i> timeout has expired). This continues until all zones are broadcasting the evac signal.
Alert -> Phased Alert/Evac	Alert	When an alarm signal assigned to an emergency zone and configured as type Alert is activated, the associated emergency zone broadcasts the alert signal (after the <i>Delay to Alert</i> timeout has expired). After the broadcast has commenced, the <i>Delay to Evac</i> timeout commences and when this expires the evac signal is broadcast to the emergency zone. Following this the next <i>Number of Zones</i> and the previous <i>Number of Zones</i> broadcast the alert signal (after the <i>Delay to Alert</i> timeout has expired). This is followed by the evac signal and continues until all zones are broadcasting the evac signal.



For more on sequencing read MAN3142 EvacU ^{ELITE} Programming Manual & MAN3169- Config FAQs

6.13 Zone delay off/on

Zones can have a programmable delay time, which delays the zone entering the emergency warning condition after the occurrence of an alarm in the zone.

Refer to section 5.4.3.1 for information on delays.

On the main menu screen, the following is displayed.

1	Menu control	
2	<p>Menu Screen</p> <p>The Zone Delay control is provided to switch delays On and Off. Delays are programmed and currently switched On – hence the Delay LED indicator is lit, and the control states ZONE DELAY ON. If the control is activated, then the display is updated as below</p>	
3	<p>Menu Screen – after the ZONE DELAY control activated. The Delay Led indicator will be extinguished.</p>	

6.14 Access level

The current access level is displayed on the Status Line – see section 5.1.2. The access level is also displayed on the Menu screen.

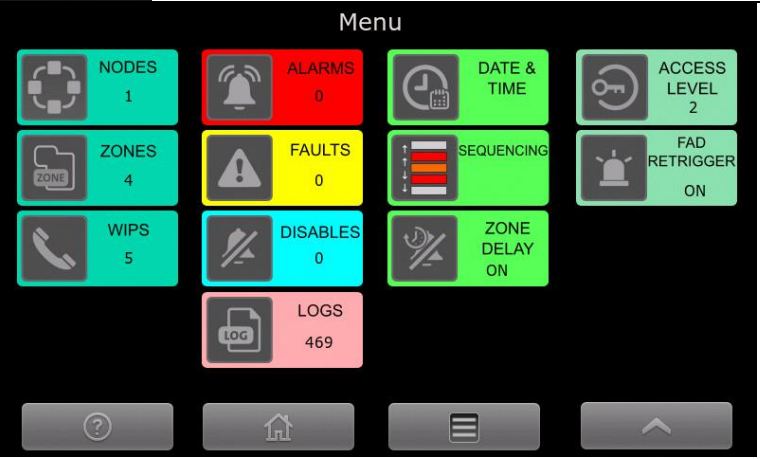
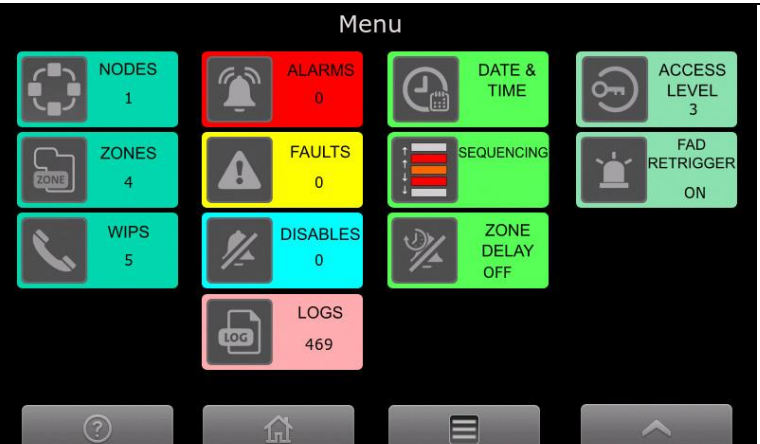

1	Menu control	
2	<p>Menu Screen</p> <p>The Access Level control displays the current access level.</p> <p>Activating the control – will prompt for a new User ID and password – see section 6.2.</p> <p>If a level 3 user ID and password is entered, the display is updated as below</p>	 <p>The screenshot shows the 'Menu' screen with the following data:</p> <ul style="list-style-type: none"> NODES: 1 ZONES: 4 WIPS: 5 LOGS: 469 ALARMS: 0 FAULTS: 0 DISABLES: 0 DATE & TIME: (empty) SEQUENCING: (empty) ZONE DELAY: ON ACCESS LEVEL: 2 FAD RETRIGGER: ON
3	Menu Screen – Showing the access level as 3.	 <p>The screenshot shows the 'Menu' screen with the following data:</p> <ul style="list-style-type: none"> NODES: 1 ZONES: 4 WIPS: 5 LOGS: 469 ALARMS: 0 FAULTS: 0 DISABLES: 0 DATE & TIME: (empty) SEQUENCING: (empty) ZONE DELAY: OFF ACCESS LEVEL: 3 FAD RETRIGGER: ON

6.15 FAD retrigger

Fire Alarm Devices (FADs) (or warning devices) are activated when the EWCIE enters the emergency warning condition (see section 5.4.3).

If the FAD retrigger is On, and the EWS is silenced (after entering the emergency warning condition), and an alarm is reported in another emergency zone, the FADs will be retriggered. If the FAD retrigger is Off, then the FADs will not be retriggered.

This facility is at access level 3.

1	Menu control	
2	Menu Screen The FAD Retrigger control shows retrigger as On. To change the setting to Off, activate the control – while at access level 3.	

7 Installation

7.1 Unpacking and inspection

Carefully check packaging prior to unpacking the goods for any external transit damage. Unpack the goods and check the goods both externally and internally for any loose or damaged components or any other problem which affects the appearance, installation or operation of the goods.

Ensure all wiring is secure, and all connections are secure, and that all fixings and earth studs are tight.

If any damage has occurred, please contact Ampac in writing within 14 days, as per Ampac's terms of sale.

7.2 Ant-static precautions

To prevent damage to panel components please ensure prior to touching or handling any of the wiring or PCBs within the Evacu^{ELITE} that you are correctly earthed.

The recommended method is to use an anti-static wrist strap and flexible lead. Fit the wrist strap to yourself and attached the flexible lead to the cabinet earth bolt located inside the top of the cabinet.

PCBs removed from the Evacu^{ELITE} should be immediately placed in an anti-static bag.

7.3 Working on the system

To prevent damage to components please ensure prior to unplugging any connector, connecting or disconnecting any wiring, removing or replacing any cards in the universal rack that both the mains and batteries have been isolated. The mains isolator is located in the top left-hand side of the cabinet and the battery isolator is located adjacent to the batteries.

7.4 Cabinet Installation

The 24U cabinet must be floor mounted. Refer to figures 7-1, 7-2 and 7-3 for cabinet dimensions, fixing points and cable entry.

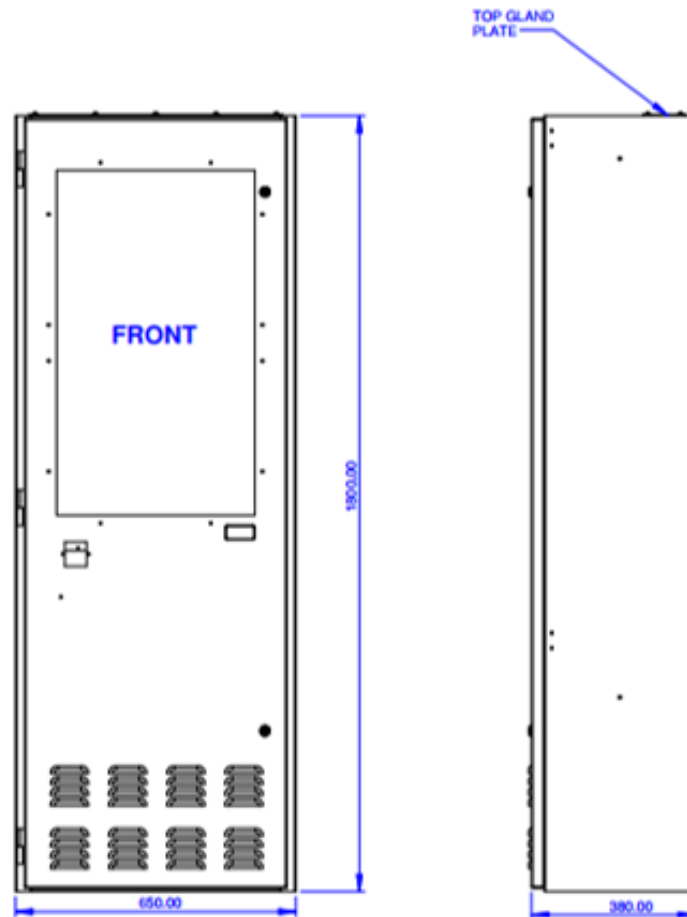

Figure 7-1 24U Cabinet – Front and side view

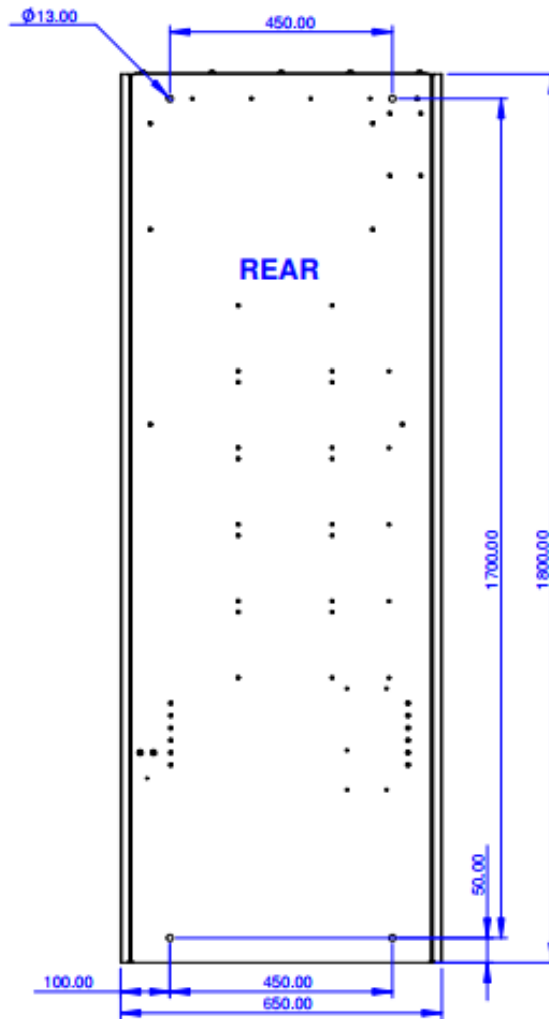

Figure 7-2 24U Cabinet - Rear view showing mounting points.

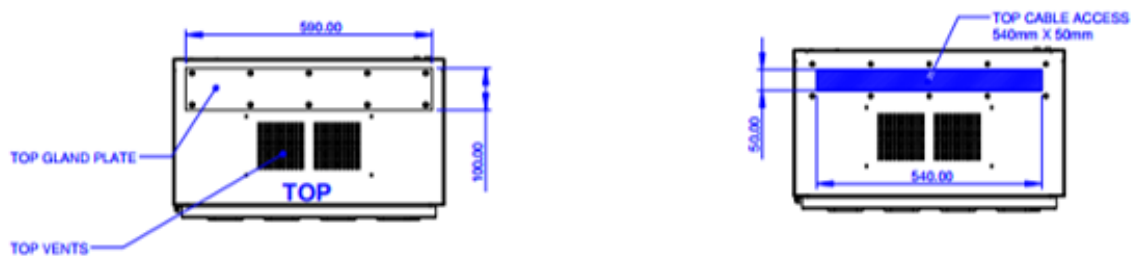

Figure 7-3 24U Cabinet – Top view showing the gland plate and cable entry.

The 13U cabinet can be floor or wall mounted. Refer to figure 7.4, 7.5 and 7.6 for cabinet dimensions, fixing points and cable entry.

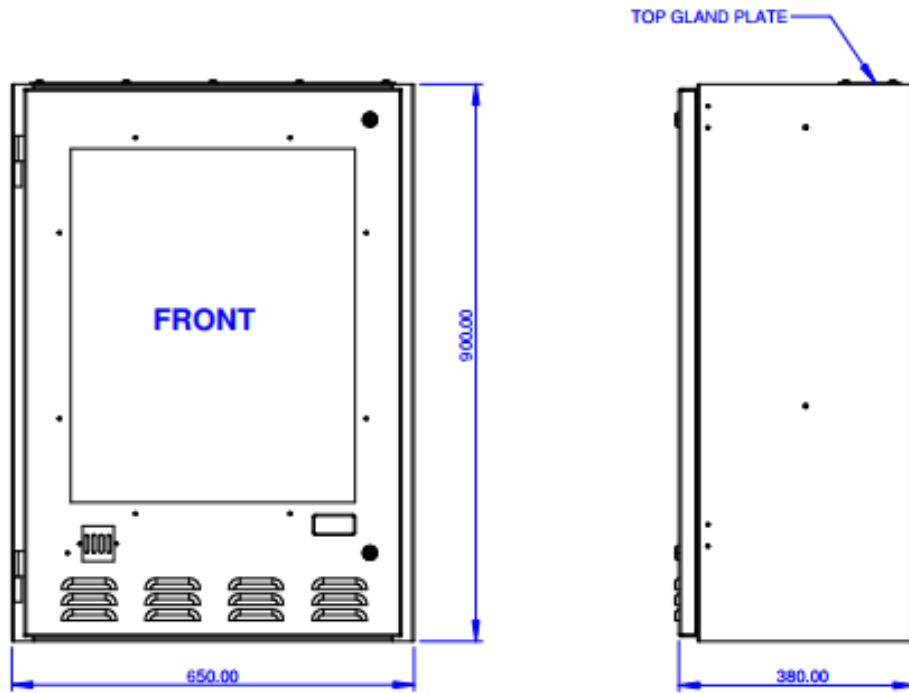

Figure 7-4 13U Cabinet - Front and side view

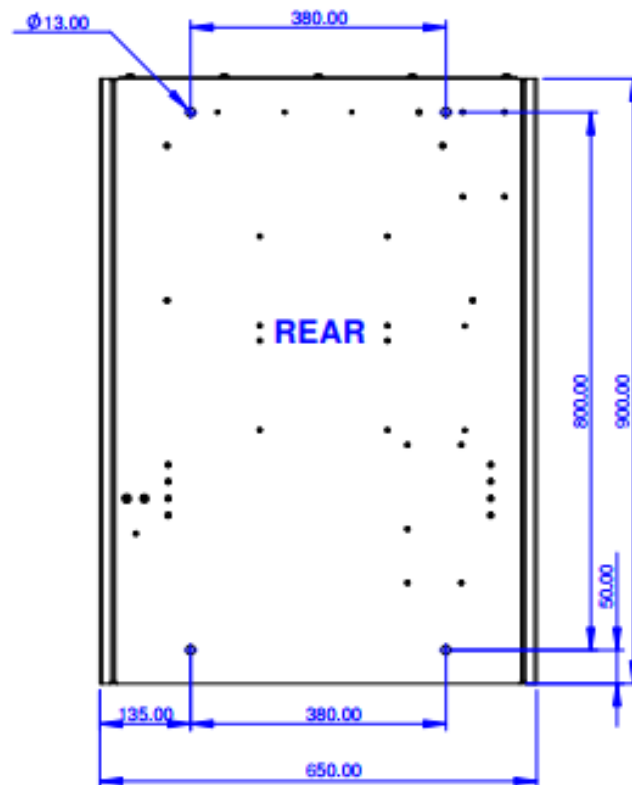

Figure 7-5 13U Cabinet - Rear view showing mounting points.

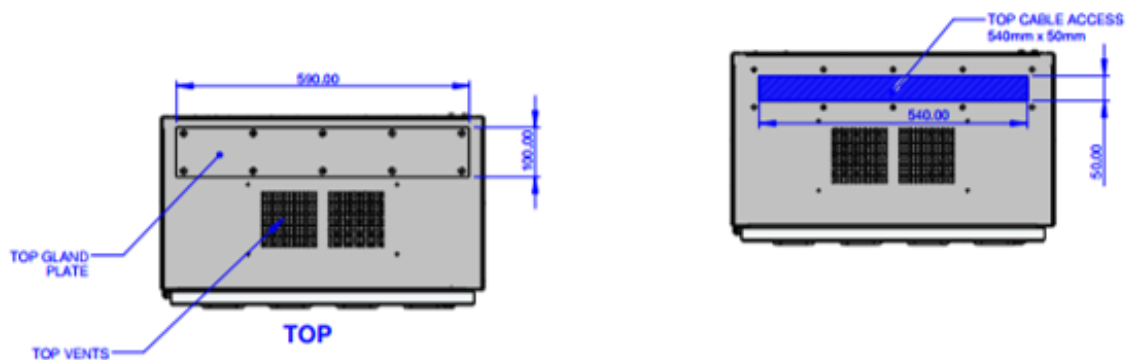

Figure 7-6 13U Cabinet - Top view showing gland plate and cable entry.

7.5 Mains termination

The cabinets (13U and 24U) are fitted with a mains isolator and earth stud, located in the top left-hand corner of the cabinet.

Please ensure the mains is connected – using the appropriately rated cable. The mains cable should conform to one of the following standards: AS/CA S008, AS/NZS 3191, AS/NZS 5000.1, AS/NZS 3808 or marked with VW-1.

The circuit breaker in the 24U is rated at 25 amps and 16 amps for the 13U cabinet. Recommended cable for the 24U is 2.5mm² and 1.5mm² for the 13U.

Following diagrams show the location of the mains isolator and earth point.

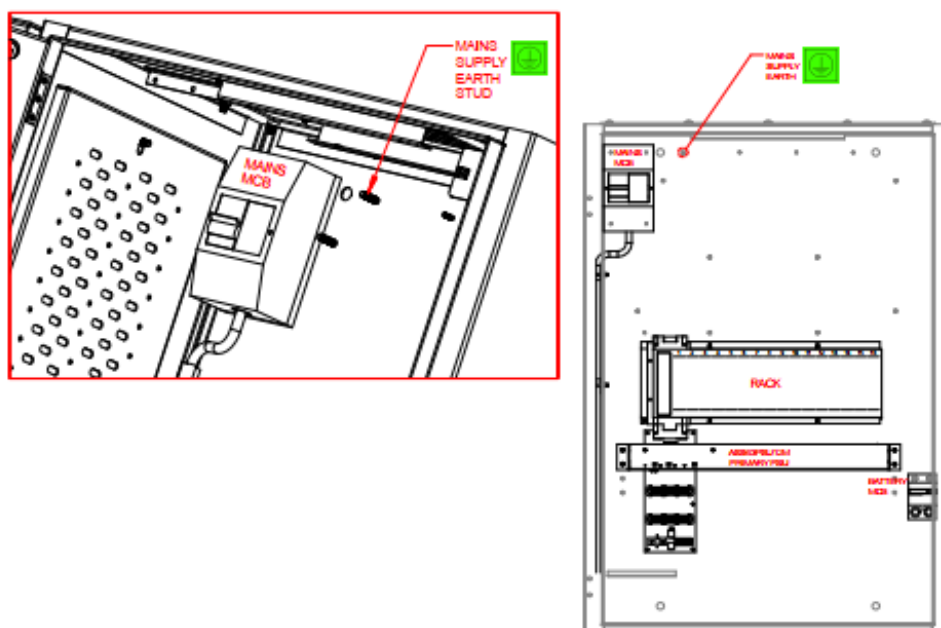

Figure 7-7 13U Cabinet showing the mains isolator, earth point and battery isolator

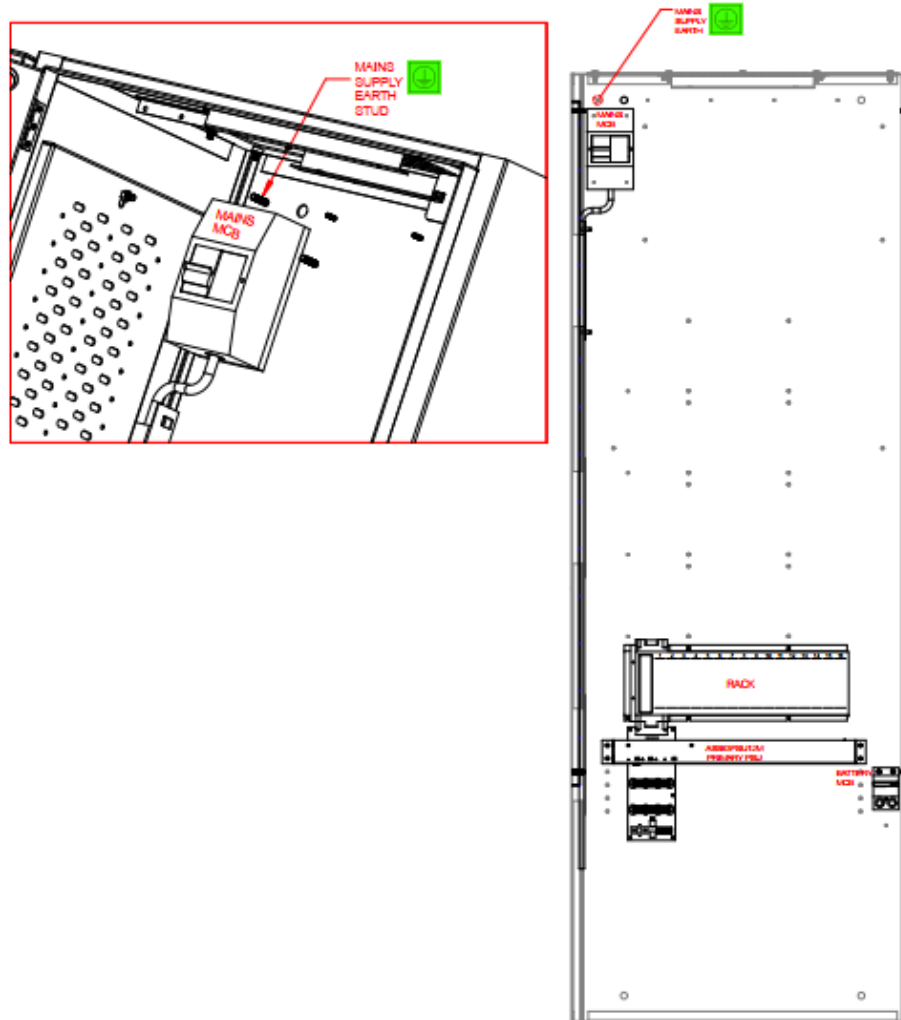

Figure 7-8 24U Cabinet showing the mains isolator, earth point and battery isolator.

7.6 Fitting cards to the universal racks

The plug-in cards for the universal rack (see section 4.2.4 and 4.2.5 for a detailed description of the cards) are packed separately to the cabinet.

The cards should be loaded into the racks as per the site configuration file.

If no configuration file has been created, then the placement of the cards to the racks should be reflected in the configuration file.

NOTE: Rack 1 is the bottom (lowest rack). Each rack must be fitted with a Distribution CPU. If the configuration has multiple cabinets (NIC required), the NIC is fixed to the Distribution CPU in rack 1.

7.7 Connecting the batteries

Before connecting the batteries, the battery isolator should be disengaged. The battery isolator is located on the rear of the cabinet, to the left of the power supply modules. Refer to Fig 7-7 for 13U cabinet and Fig 7-8 for 24U cabinet.

The number of power supply modules fitted determines the rating of the battery isolator and the battery cabling size. The actual battery cable required does depend on the type of lugs on the batteries.

No. of power supplies fitted	Rating of battery isolator	Battery cable
1	60 amps	CAB3074 – M6 lugs 16mm ² cable
		CAB3075 – M10 lugs 16mm ² cable
2	120 amps	CAB3076 – M10 lugs 25mm ² cable
3	175 amps	CAB3077 – M10 lugs 35mm ² cable

PSU Upgrade scenarios. In the event where a system upgrade is necessary careful consideration is required when adding **Universal Racks or HPAs or MOCs**. It is necessary to evaluate the **PSU upgrade path** so the panel copes with any new loads applied and suits the revised system configuration.

The information table below provides concise direction on this topic.

You will also need to **REDO a new battery calculation** to install the correct battery size to meet AS7240.4

EVACU ELITE POWER SUPPLY SELECTION (PANEL UPGRADE OF EXISTING PSU)				
General Table				
PSU UPGRADE REQUIREMENT	EXISTING PSU RATING	NEW PSU RATING	UPGRADE KIT ITEM NO.	QTY
1X PSU TO 2X PSU	1200W	2400W	6350-PSUS-CSO	1X
			6350-MCB120A-CSO	1X
1X PSU TO 3X PSU	1200W	3600W	6350-PSUS-CSO	2X
			6350-MCB175A-CSO	1X
2X PSU TO 3X PSU	2400W	3600W	6350-PSUS-CSO	1X
			6350-MCB175A-CSO	1X

EVACU ELITE ADDITIONAL NODE POWER SUPPLY SELECTION (PANEL UPGRADE - NEW NODE, NEW PSU)				
NEW NODE PSU REQUIREMENT	PSU RATING	UPGRADE KIT ITEM NO.	DESCRIPTION	QTY
1X PSU	1200W	6350-PSUM-CSO	PSU PRIMARY	1X
		6350-MCB25A-CSO	MAINS MCB, CABLES, PDB	1X
		6350-MCB60A-CSO	60A CB BATTERY ISOLATOR & CABLES	1X
2X PSU	2400W	6350-PSUM-CSO	PSU PRIMARY	1X
		6350-PSUS-CSO	PSU SECONDARY	1X
		6350-MCB25A-CSO	MAINS MCB, CABLES, PDB	1X
		6350-MCB120A-CSO	120A CB BATTERY ISOLATOR & CABLES	1X
3X PSU	3600W	6350-PSUM-CSO	PSU PRIMARY	1X
		6350-PSUS-CSO	PSU SECONDARY	2X
		6350-MCB25A-CSO	MAINS MCB, CABLES, PDB	1X
		6350-MCB175A-CSO	175A CB BATTERY ISOLATOR & CABLES	1X

7.8 Recommended Batteries

The maximum capacity battery that can be fitted to the 13U cabinet is 12V 100 Ah.

The maximum capacity battery that can be fitted to the 24U cabinet is 12V 190 Ah.

Certified 12VDC sealed lead acid batteries shall be used in the 13U and 24U Evacu^{ELITE} cabinets.

As per IEC 62368, certified batteries shall comply with the following relevant standards: IEC 60086-4, IEC 60086-5, IEC 60896-11, IEC 60896-21, IEC 60896-22, IEC 61056-1 and IEC 61056-2, IEC 61427, IEC/TS 61430, IEC 61434, IEC 61959, IEC 62133, IEC 62281, and IEC 62485-2.

8 Connecting to the Evacu^{ELITE}

8.1.1 General

The mains termination is to the mains isolator located in the top left hand of the cabinet.

All other terminations are accommodated to the front of the cards mounted in the universal racks.

The following label is located on the inner door and details terminations for all cards.

BRD63CPU - Distribution CPU				BRD63NIC - Network Card				BRD63ILC Intercom Line Card		BRD63LILC Loop Intercom Line Card				BRD63LPA Dial 25W		BRD63HPA 150W		BRD63MOC - Multi OIP Card				BRD63MIC - Multi IP Card			
BGM 1 HOT	1	2		BGM 2 HOT				WIP LINE 1	1	1		LOOP 1 OUT (+ve)	1	1	OIP 1 (+ve)	1	OIP 1 (OV)	1	2	OIP 1 (+ve)	OIP 1 Voltage Reversing +	INPUT 1 (REF)	1	2	INPUT 1
BGM 1 COLD	3	4		BGM 2 COLD				WIP LINE 2	2			LOOP 1 IN (+ve)	2		OIP 1 (+ve)	2	OIP 2 (OV)	3	4	OIP 2 (+ve)	OIP 2 Voltage Reversing -	INPUT 2 (REF)	3	4	INPUT 2
BGM 1 SHIELD	5	6		BGM 2 SHIELD				WIP LINE 3	3			LOOP 2 OUT (+ve)	3		OIP 2 (+ve)	3	OIP 3 (OV)	5	6	OIP 3 (+ve)	OIP 3 Voltage Reversing +	INPUT 3 (REF)	5	6	INPUT 3
WP 1 (IN)	7	8		WP 1 (OV)				WIP LINE 4	4			LOOP 2 IN (+ve)	4		OIP 2 (+ve)	4	OIP 4 (OV)	7	8	OIP 4 (+ve)	OIP 4 Voltage Reversing -	INPUT 4 (REF)	7	8	INPUT 4
IP 1 (IN)	9	10		IP 2 (OV)				WIP LINE 5	5			LOOP 3 OUT (+ve)	5		OIP 2 (+ve)	5	OIP 5 (OV)	9	10	OIP 5 (+ve)	OIP 5 Voltage Reversing +	INPUT 5 (+VE)	9	10	INPUT 5
RLY 1 (NO 1)	11	12		RLY 1 (NC 2)				WIP LINE 6	6			LOOP 3 IN (+ve)	6		OIP 2 (+ve)	6	OIP 6 (OV)	11	12	OIP 6 (+ve)	OIP 6 Voltage Reversing -	INPUT 6 (+VE)	11	12	INPUT 6
RLY 1 (COM 1)	13	14		RLY 1 (COM 2)				WIP LINE 7	7			LOOP 4 OUT (+ve)	7		OIP 3 (+ve)	7	OIP 7 (OV)	13	14	OIP 7 (+ve)	OIP 7 Voltage Reversing +	INPUT 7 (+VE)	13	14	INPUT 7
RLY 2 (NO)	15	16		RLY 3 (NO)				WIP LINE 8	8			LOOP 4 IN (+ve)	8		OIP 3 (+ve)	8	OIP 8 (OV)	15	16	OIP 8 (+ve)	OIP 8 Voltage Reversing -	INPUT 8 (+VE)	15	16	FAULT FIB RESISTOR
RLY 2 (COM)	17	18		RLY 3 (COM)																	INPUT 8 (+VE)	17	18		
RLY 2 (NC)	19	20		RLY 3 (NC)																					

BRD63GUI - Primary Graphical User Interface							
CM	1	2	3	4	5	6	7
USB	IP-1	IP-1 COM	IP-2	IP-2 COM	IP-3	IP-3 COM	IP-4

BOARD TERMINATION LABEL LAB3203							
GROUND	1	2	GROUND				
RS 232 CTS	3	4	RS 232 RTS				
RS 232 RX	5	6	RS 232 TX				

Figure 8-1 Label 3203 detailing terminations for each card type

8.2 Distribution CPU

8.2.1 Connections

Following table details the field connections to the distribution CPU. **CPU Version A shown.**

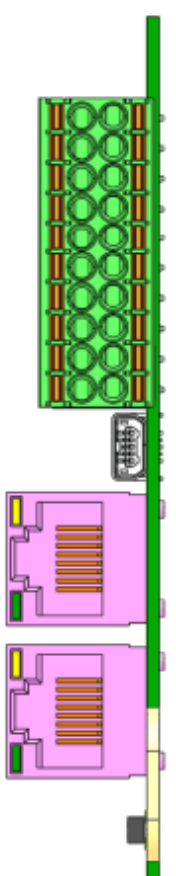

BGM 1 HOT	1	2	BGM 2 HOT
BGM 1 COLD	3	4	BGM 2 COLD
BGM 1 SHIELD	5	6	BGM 2 SHIELD
INPUT 1	7	8	INPUT 1 (REF)
INPUT 2	9	10	INPUT 2 (REF)
RELAY 1-1 (NO)	11	12	RELAY 1-2 (NC)
RELAY 1-1 (COM)	13	14	RELAY 1-2 (COM)
RELAY 2 (NO)	15	16	RELAY 3 (NO)
RELAY 2 (COM)	17	18	RELAY 3 (COM)
RELAY 2 (NC)	19	20	RELAY 3 (NC)

Mini USB Connector

RJ45 1 provides the network connection to the GUI.

RJ45-2 Redundant connection to the GUI (Provision for Future Ampac RPC)

Notes about BGM
 In the Windows programming tool screen
 BGM 1 Connection = BGM Input 1 ID
 BGM 2 Connection = BGM Input 2 ID

BGM source numbering guide.
 A BGM source number may be applied to each amplifier in the system config.
When a BGM source is distributed to multiple panels Use source numbers 1 & 2 only
 When a BGM source is distributed through local panel racks only use source numbers starting from 100 then 101 102 and so on if you have multiple local BGM sources

Audio 1 & 2	Analog line level audio input (hot, cold and shield), 10kΩ impedance, max input +4dBu
Input 1 & 2	Supervised input, selectable EOL, common reference.
Relay 1	Double pole, single throw (1 x NO, 1 x NC, 2 x COM)
Relay 2 & 3	Single pole, double throw (COM, NO, NC)
Mini USB	<i>Not available for field connection</i>
RJ45 1	<i>Not available for field connection</i>
RJ45-2	<i>Not available for field connection</i>

Note: **Version B CPU** is used in when a PAIC (Public Address interface Card) is fitted. This unique version includes an Audio Jack which interconnect the Emergency Warning System to the PA system.

BGM Audio inputs 1 and 2 are available for connecting Local (or *Global) BGM sources.

(*Read BGM notes 8.2.1)

CPU Inputs 1 and 2 are general purpose inputs.

CPU Relays 1, 2 and 3 are general purpose output.

8.2.2 Indications

The Distribution CPU has one status indicator, located adjacent to RJ45 2. See below.

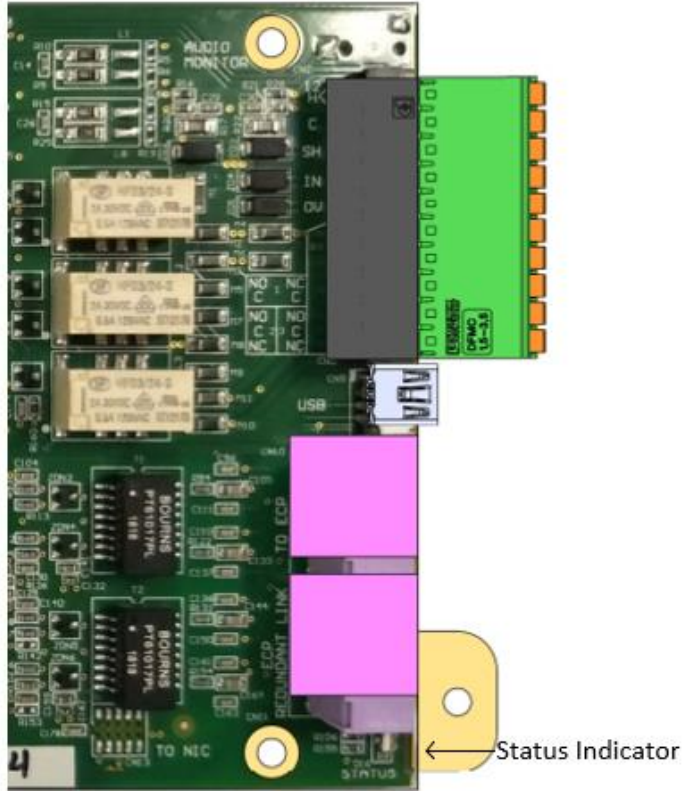
	<p>Status Indicator</p> <p>OFF: cards have no power or processor is fault</p> <p>FLASHING GREEN: board is operating, no faults.</p> <p>FLASHING AMBER: board has a fault condition.</p>
--	--

8.3 Multi-purpose output card (MOC)

8.3.1 Connections

Following table details the field connections to the MOC.



OUTPUT 1 (0VDC)	1	2	OUTPUT 1 (+VE)
OUTPUT 2 (0VDC)	3	4	OUTPUT 2 (+VE)
OUTPUT 3 (0VDC)	5	6	OUTPUT 3 (+VE)
OUTPUT 4 (0VDC)	7	8	OUTPUT 4 (+VE)
OUTPUT 5 (0VDC)	9	10	OUTPUT 5 (+VE)
OUTPUT 6 (0VDC)	11	12	OUTPUT 6 (+VE)
OUTPUT 7 (0VDC)	13	14	OUTPUT 7 (+VE)
OUTPUT 8 (0VDC)	15	16	OUTPUT 8 (+VE)

When 2 wire voltage reversal output is required (Configured in the PC Programming App), The +VE output is two consecutive outputs are used. The 0VDC outputs are unused.

NOT USED	1	2	OUTPUT 1 (+VE)
NOT USED	3	4	OUTPUT 1 (-VE)
NOT USED	5	6	OUTPUT 2 (+VE)
NOT USED	7	8	OUTPUT 2 (-VE)
NOT USED	9	10	OUTPUT 3 (+VE)
NOT USED	11	12	OUTPUT 3 (-VE)
NOT USED	13	14	OUTPUT 4 (+VE)
NOT USED	15	16	OUTPUT 4 (-VE)

Outputs 1, 2, 3, 4, 5, 6, 7 and 8	Single ended supervised output/ paired output (voltage reversal), max 2 amps per output and 6 amps per card. Selectable EOL (3K3, 4K7, 10K). Output voltage range 12 to 28VDC.
-----------------------------------	--

The outputs are typically used to drive VADs. Applicable Ampac Item number are:

Ceiling Mount

Item Number	Description
4107-1101	VXB-VC Ceiling mount white flash shallow white body
4107-1102	VXB-VC Ceiling mount white flash deep white body
4107-1103	VXB-VC Ceiling mount red flash shallow white body
4107-1104	VXB-VC Ceiling mount red flash deep white body
4107-1105	VXB-VC Ceiling mount red flash shallow red body
4107-1106	VXB-VC Ceiling mount red flash deep red body
4107-1107	VXB-VC Ceiling mount white flash shallow red body
4107-1108	VXB-VC Ceiling mount white flash deep red body
4107-1109	VXB-VC Ceiling mount amber flash shallow white body
4107-1110	VXB-VC Ceiling mount amber flash deep white body

Wall mount

Item Number	Description
4107-1151	VXB-VW Wall mount white flash shallow white body
4107-1152	VXB-VW Wall mount white flash deep white body
4107-1153	VXB-VW Wall mount red flash shallow white body
4107-1154	VXB-VW Wall mount red flash deep white body
4107-1155	VXB-VW Wall mount red flash shallow red body
4107-1156	VXB-VW Wall mount red flash deep red body
4107-1157	VXB-VW Wall mount white flash shallow red body
4107-1158	VXB-VW Wall mount white flash deep red body
4107-1159	VXB-VW Wall mount amber flash shallow white body
4107-1160	VXB-VW Wall mount amber flash deep white body

Dual ceiling mount strobes

Item Number	Description
4107-1131	Dual VXB Ceiling mount red and white flash shallow white body
4107-1132	Dual VXB Ceiling mount red and white flash deep white body
4107-1133	Dual VXB Ceiling mount red and amber flash shallow white body
4107-1134	Dual VXB Ceiling mount red and amber flash deep white body

Cabling

No. of Devices	1.0mm ² Field Wiring	1.5mm ² Field Wiring
10	444m	620m
20	222m	310m
30	148m	207m
40	111m	155m

8.3.2 Indicators

The Multi-purpose output card (MOC) has one status indicator per output (8) and a general status indicator. See below.

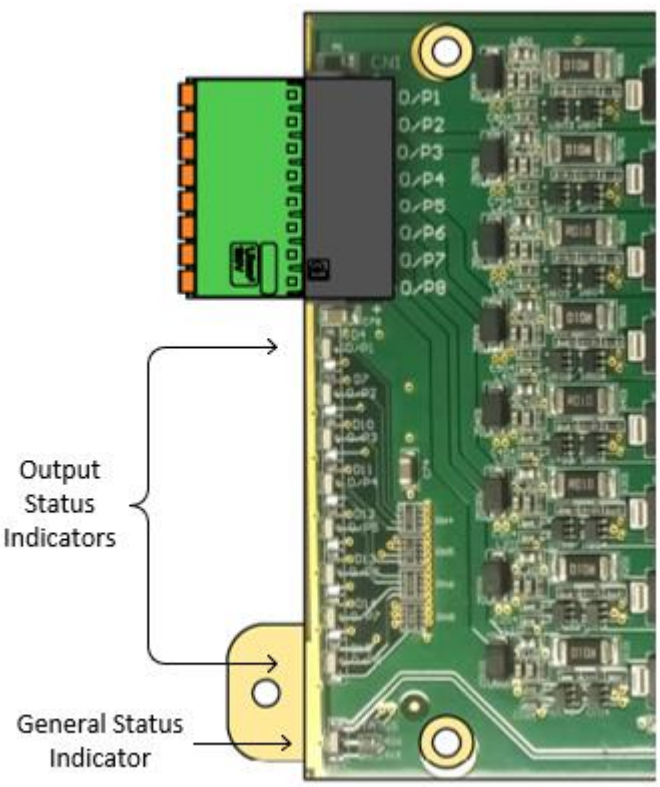
 <p>The diagram shows a green printed circuit board (PCB) with various components. On the left side, there is a connector with 8 pins. Below the connector, there are 8 small circular indicators labeled O/P1 through O/P8. At the bottom of the board, there is a larger yellow circular indicator labeled 'General Status Indicator'. Arrows point from the text labels to the corresponding indicators on the board.</p>	<p>Output Status Indicators</p> <p>Dual indicators</p> <p>RED: Output is activated</p> <p>FLASHING AMBER – Fault condition</p> <p>General Status Indicator</p> <p>OFF: cards have no power or processor is fault</p> <p>FLASHING GREEN: board is operating, no faults.</p> <p>FLASHING AMBER: board has a fault condition.</p> <p>STEADY AMBER: Not receiving commands from the Distribution CPU</p>
--	--

8.3.3 Field wiring

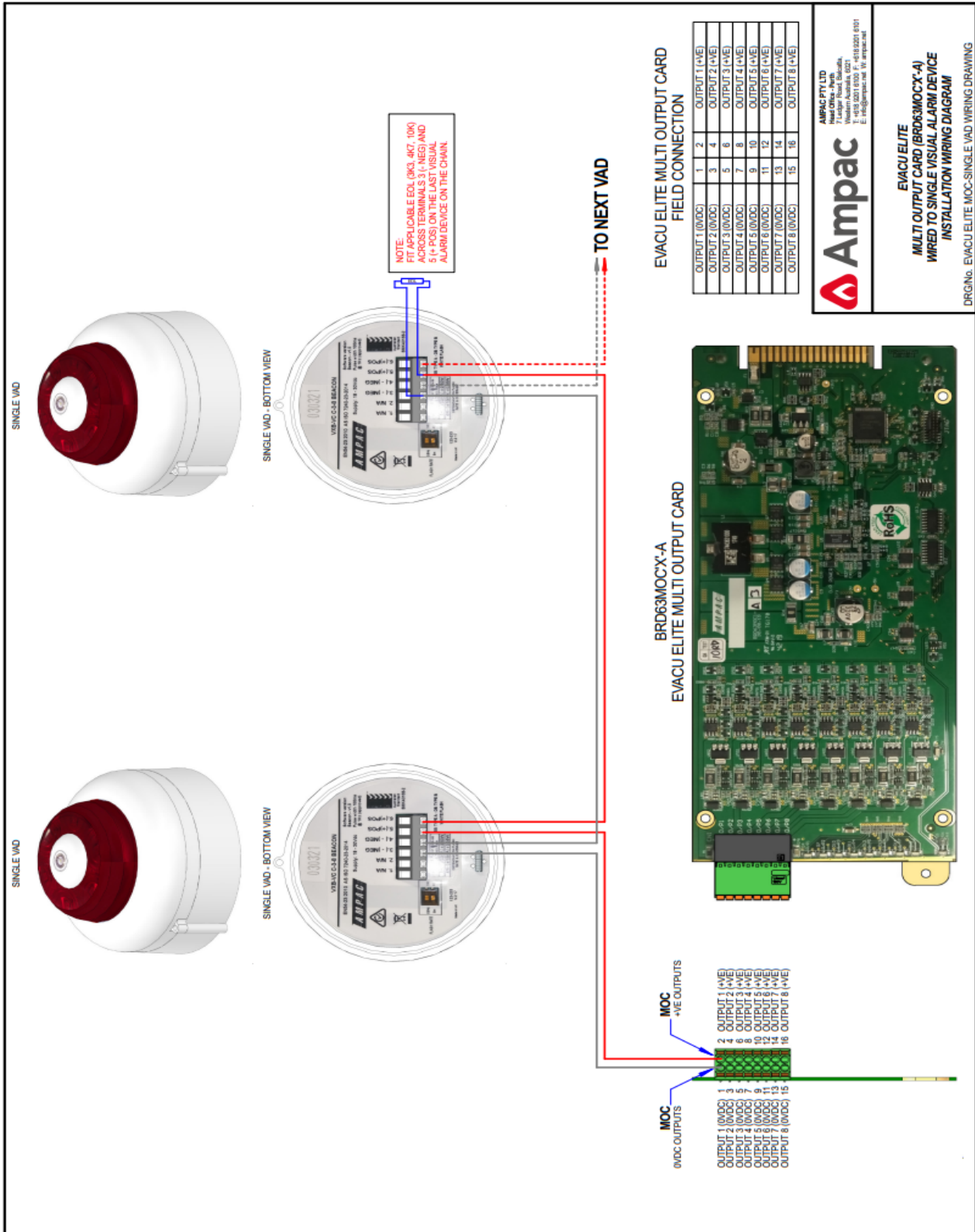

Figure 8-2 MOC wiring – Standard Single End VAD Output

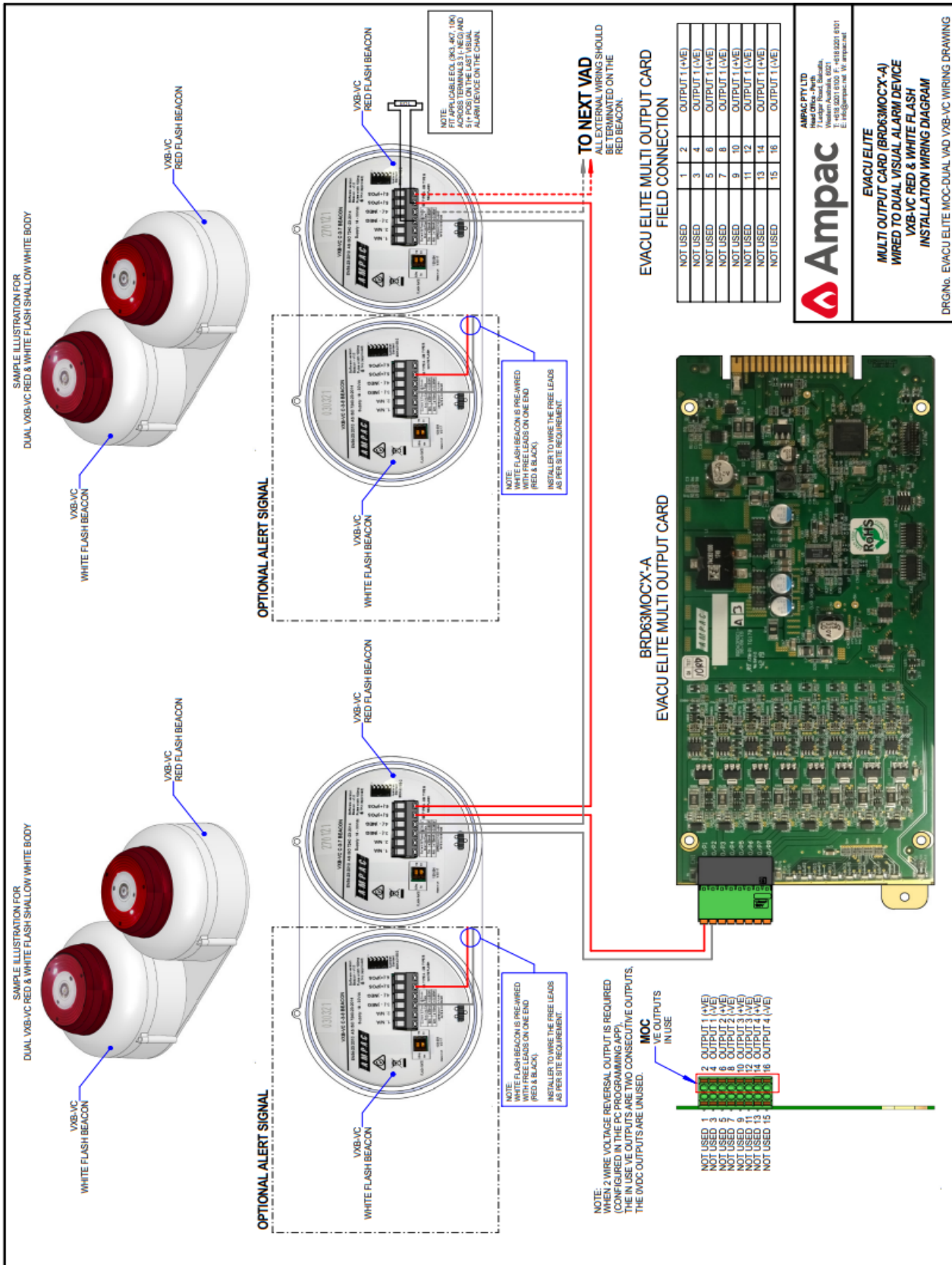
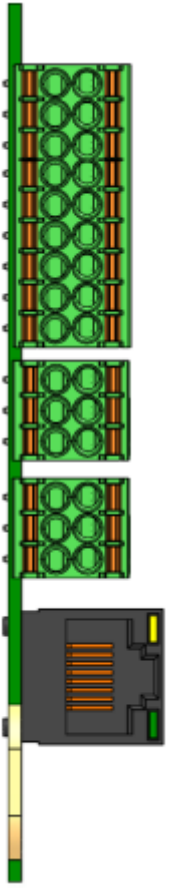

Figure 8-3 MOC wiring - Voltage Reversal Method (Used for Dual Strobe or Dual VAD options)

8.4 Multi-purpose interface card (MIC)

8.4.1 Connections

Following table details the field connections to the MIC.



INPUT 1 (CREF)	1	2	INPUT 1
INPUT 2 (CREF)	3	4	INPUT 2
INPUT 3 (CREF)	5	6	INPUT 3
INPUT 4 (CREF)	7	8	INPUT 4
INPUT 5 (-VE)	9	10	INPUT 5 (+VE)
INPUT 6 (-VE)	11	12	INPUT 6 (+VE)
INPUT 7 (-VE)	13	14	INPUT 7 (+VE)
INPUT 8 (-VE)	15	16	FAULT F/B RESISTOR
INPUT 8 (+VE)	17	18	

RELAY 2 (NC)	1	2	RELAY 1 (NC)
RELAY 2 (COM)	3	4	RELAY 1 (COM)
RELAY 2 (NO)	5	6	RELAY 1 (NO)

GROUND	1	2	GROUND
RS 232 CTS	3	4	RS232 RTS
RS 232 RX	5	6	RS 232 TX

Interface to Ampac FireFinder^{PLUS} Add On bus.

Refer Section 14: Shows connections between MIC card and FireFinder Plus CPI board (Common Power Supply Interface Card) and also between the PCC board found in the Primary PSU module and the FACP brigade card.

Input 1, 2, 3 and 4	Single ended inputs, common floating reference with selectable EOL
Input 5, 6 and 7	Differential inputs, individual floating reference with selectable EOL
Input 8	Differential input, with floating reference with fault feedback (user selectable resistance)
Relay 1 and 2	Single pole, double throw (COM, NO, NC)
Serial	RS232C serial port, with CTS and RTS available. Currently unused
FACP	Add On bus connection to the Ampac FireFinder ^{PLUS}

Inputs 1 thru 8 are typically used as alarm inputs. Input 8 has a user selectable fault feedback resistor.

Relays 1 and 2 are general purpose.

The RJ45 connector is dedicated as the HLI to the FireFinder^{PLUS}

8.4.2 Indications

The Multi-purpose interface card has one status indicator, located adjacent to the Ampac FireFinder^{PLUS} Add On bus connector.

 <p>Status Indicator →</p>	<p>Status Indicator</p> <p>OFF: cards have no power or processor is fault</p> <p>FLASHING GREEN: board is operating, no faults.</p> <p>FLASHING AMBER: board has a fault condition.</p> <p>STEADY AMBER: Not receiving commands from the Distribution CPU</p>
--	--

Hard Contact FIP Input connections x 8. Showing a 470 ohm in line resistor fitted on each.

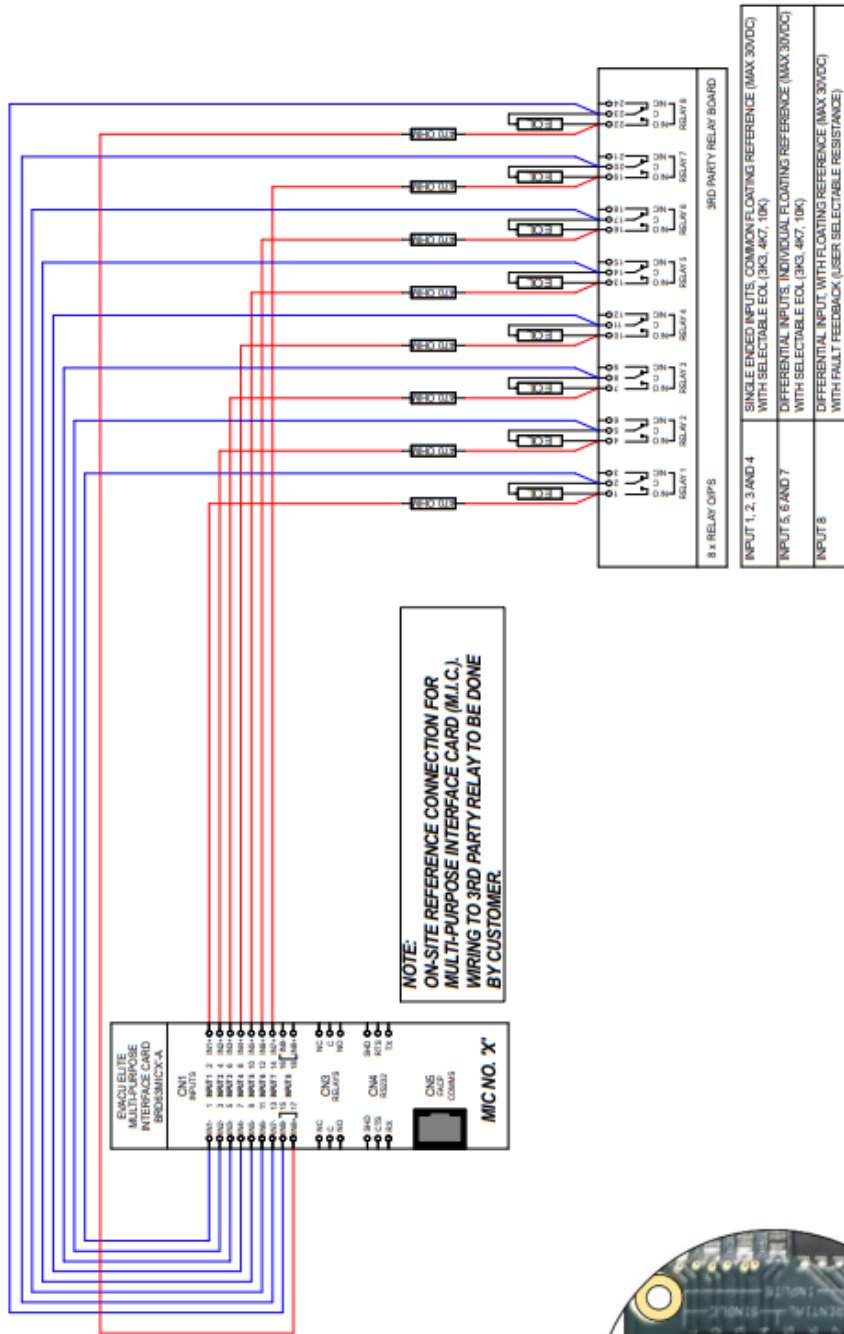

EVACU ELITE MULTI-PURPOSE INTERFACE CARD BRD3MIC X-A	
INPUT 1 (REF)	1
INPUT 2 (REF)	2
INPUT 3 (REF)	3
INPUT 4 (REF)	4
INPUT 5 (-VE)	5
INPUT 6 (-VE)	6
INPUT 7 (-VE)	7
INPUT 8 (+VE)	8
FAULT/FB RESISTOR	9
RELAY 1 (COM)	10
RELAY 1 (NO)	11
RELAY 1 (NC)	12
RELAY 2 (COM)	13
RELAY 2 (NO)	14
RELAY 2 (NC)	15
GROUND	16
RS 232 CTS	17
RS 232 RX	18
RS 232 RTS	19
RS 232 TX	20

NOTE:
ON-SITE REFERENCE CONNECTION FOR MULTI-PURPOSE INTERFACE CARD (M.I.C.), WIRING TO 3RD PARTY RELAY TO BE DONE BY CUSTOMER.

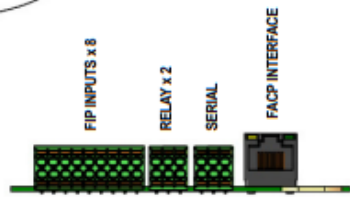
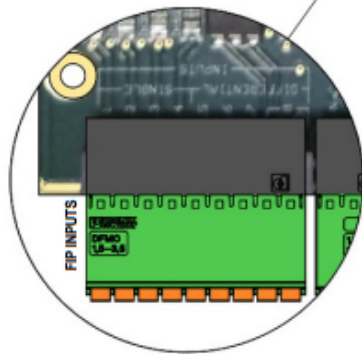

8 x RELAY DFFS	
INPUT 1, 2, 3 AND 4 WITH SELECTABLE EOL (3KΩ, 4K7, 10K)	RELAY 1
INPUT 5, 6 AND 7 WITH SELECTABLE EOL (3KΩ, 4K7, 10K)	RELAY 2
INPUT 8 DIFFERENTIAL INPUT WITH FLOATING REFERENCE (MAX 30VDC) WITH FAULT FEEDBACK (USER SELECTABLE RESISTANCE)	RELAY 3

<p>AMPAQ PTY LTD Head Office - Perth 10000000 Waverley Australia, 6021 T: +618 9201 6100 F: +618 9201 6101 E: info@ampac.net W: ampac.net</p>	
<p>No. 0 INITIAL RELEASE 1 CHANGE DWG TO ADD FROM EOL AS PER IAN M. P123022 2 CHANGE FROM EOL TO 4K7 AS PER IAN M. P123022 3 REVERT BACK TO 4K7 EOL, CHANGE NOT WIRING TO 3RD P. P123022</p>	<p>REVISION</p>
<p>PT. 25/10/22 J.M. CURN DATE CHD:APPO</p>	<p>25/10/22</p>
<p>EVACU ELITE FIP INPUTS VIA MULTI-PURPOSE INTERFACE CARD (M.I.C.) WIRING DIAGRAM</p>	
<p>DRG'NG. EVACU ELITE FIP INPUTS VIA MIC DWG</p>	

8.5 Dual 25Watt amplifier

8.5.1 Connections

Following table details the field connections for the Dual 25Watt amplifier.

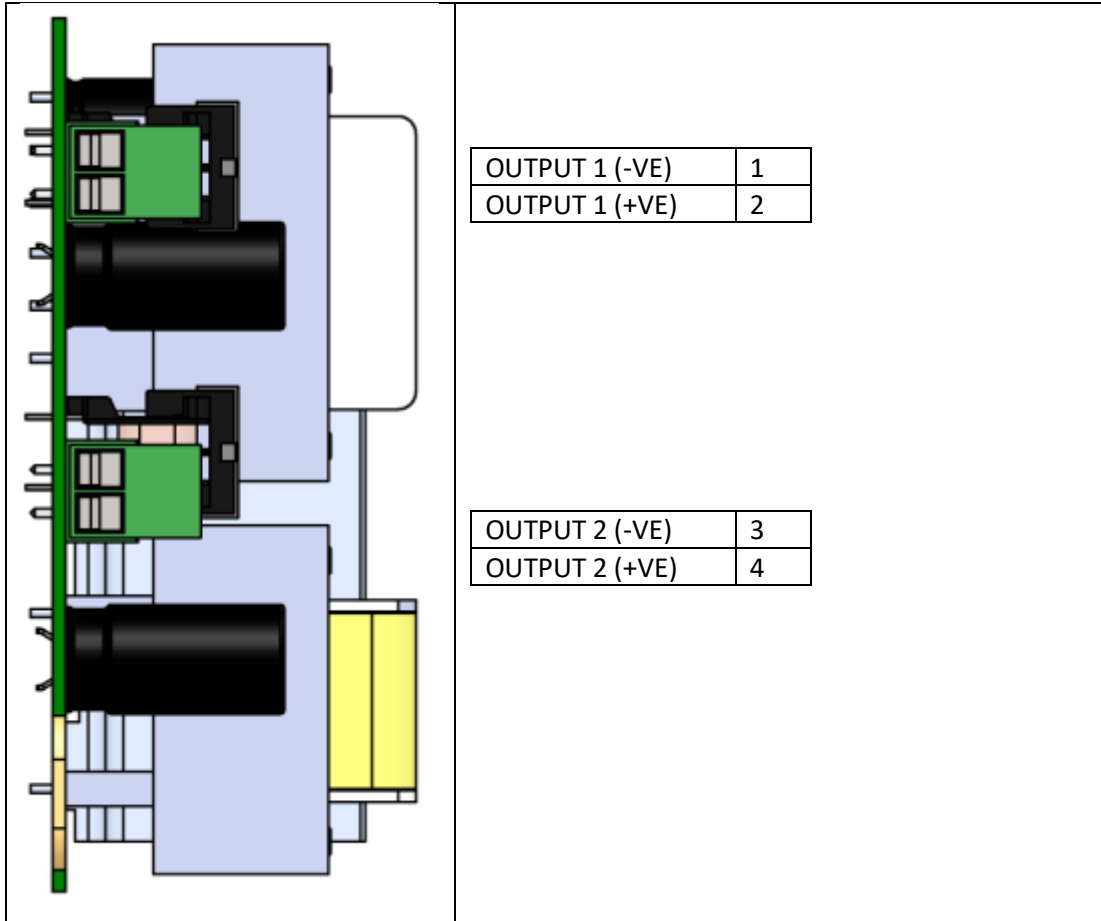

Max Drive Voltage	100V rms @ full load
Distortion	<=0.1%@ 25Watt x2
Frequency Response (AS 4428.16)	400 Hz to 10kHz +/- 1dB w.r.t. 1kHz 200 Hz to 12kHz +/- 3dB w.r.t. 1kHz
SNR	>=70%
Speaker Circuit Monitoring	DC, nominal 47kΩ

Ampac speaker item numbers

Item Number	Description
4113-1006	Ceiling speaker 4" 5W white
4113-1007	Ceiling speaker 4" 5W black
4113-1014 / 54	Ceiling speaker 4" 5W white low profile / grommets
4113-1015 / 55	Ceiling speaker 4" 5W black low profile /grommets
4113-1016 / 56	Ceiling speaker 4" 5W white low profile aluminium grill / grommets
4113-1017 / 57	Ceiling speaker 4" 5W black low profile aluminium grill / grommets
4113-1020	Grey 10W horn speaker
4113-1021	Black 10W horn speaker
4113-1022	Red 10W horn speaker

4113-1023	White 10W horn speaker
4113-1030	Surface mount speaker 4" 5W white
4113-1031	Surface mount speaker 4" 5W black
4113-1034	Surface mount speaker 8" 15W white
4113-1035	Surface mount speaker 8" 15W black
4113-1074	Ceiling speaker 8" 15W low profile white
4113-1075	Ceiling speaker 8" 15W low profile black

The following table details audio load, wire size and length of cable runs.

Calculations are based on a 1 dB of loss (approx. 10V attenuation at the end of the cable run)

Amp Size	Load Impedance	1.0mm ² Field Wiring	1.5mm ² Field Wiring	2.5mm ² Field Wiring	Maximum Capacitance
25Watt	400Ω	493m	500m	500m*	*75nF

Max capacitance must be below 75nF, and max inductance must be below 1mH.

8.5.2 Indicators

The Dual 25Watt amplifier card has one status indicator per amplifier output (2) and a general status indicator. See below.

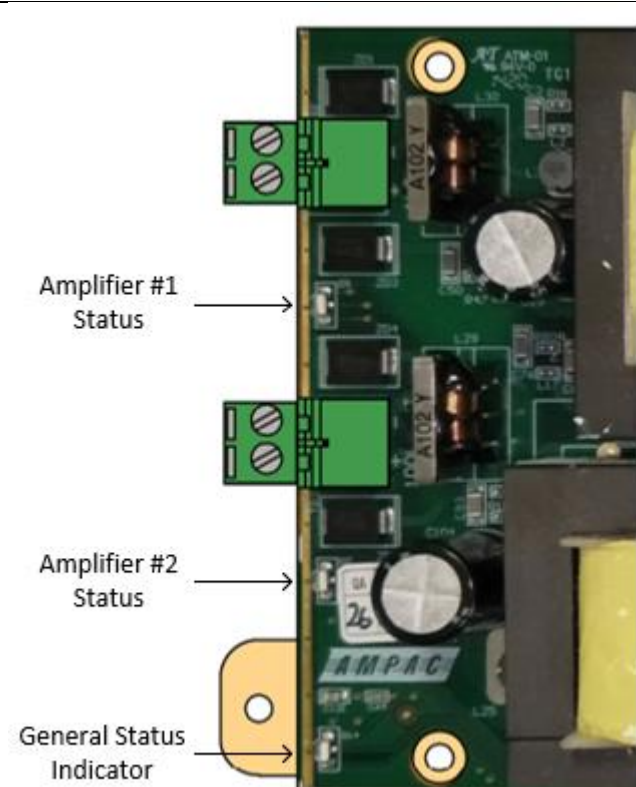
 <p>Amplifier #1 Status</p> <p>Amplifier #2 Status</p> <p>General Status Indicator</p>	<p>Amplifier Status Indicators</p> <p>Dual indicators</p> <p>RED: Output is activated (should be red all the time – showing the test tone is being broadcast)</p> <p>FLASHING AMBER – Fault condition – short circuit / open circuit.</p> <p>General Status Indicator</p> <p>OFF: cards have no power or processor is fault</p> <p>FLASHING GREEN: board is operating, no faults.</p> <p>FLASHING AMBER: board has a fault condition.</p> <p>STEADY AMBER: Not receiving commands from the Distribution CPU</p>
---	---

8.5.3 Field wiring

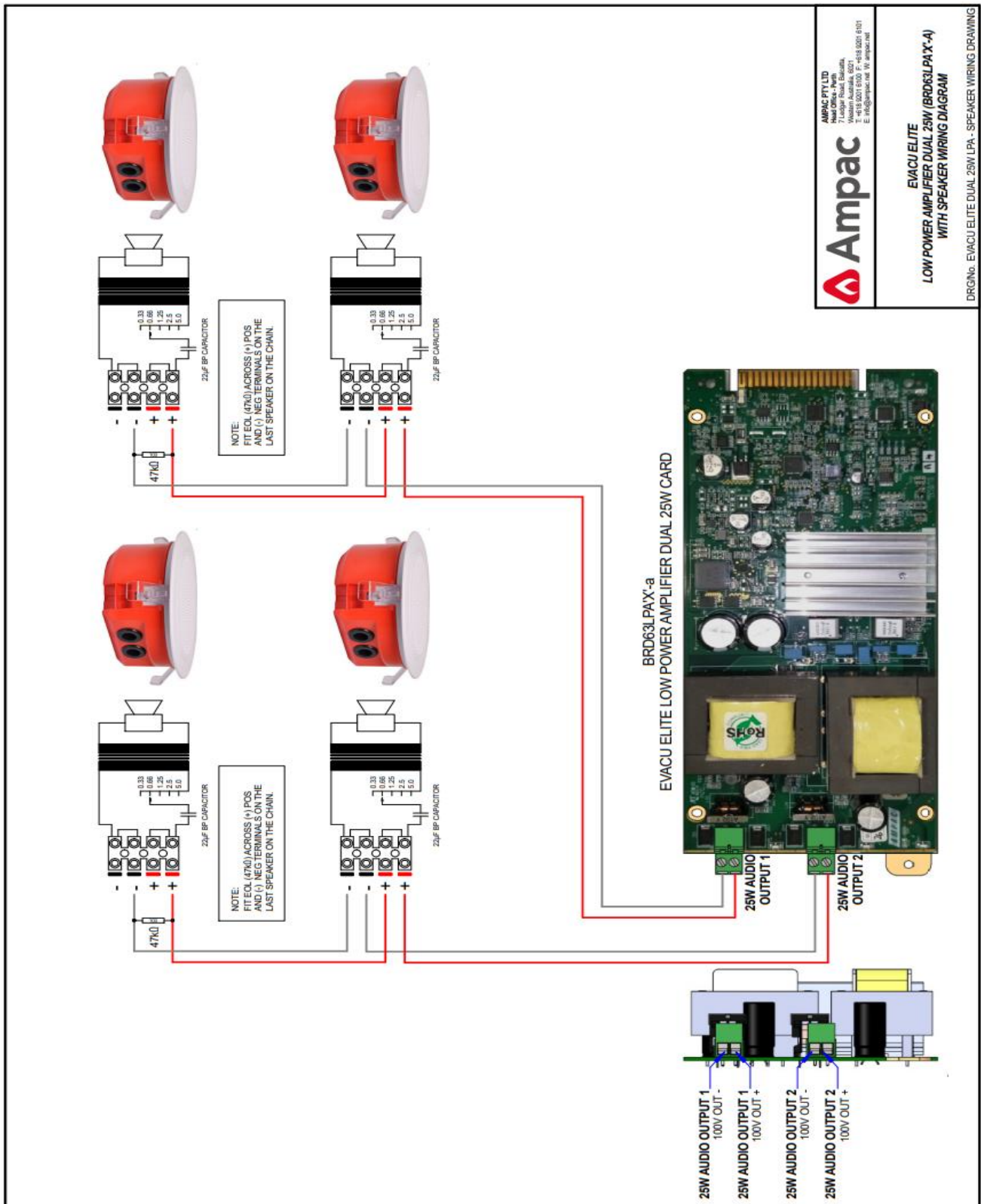

Figure 8-4 Dual 25Watt amplifier wiring

Refer to section 8.11 for detail on cable terminations and routings.

8.6 50Watt amplifier

8.6.1 Connections

Following table details the field connections for the 50Watt amplifier.

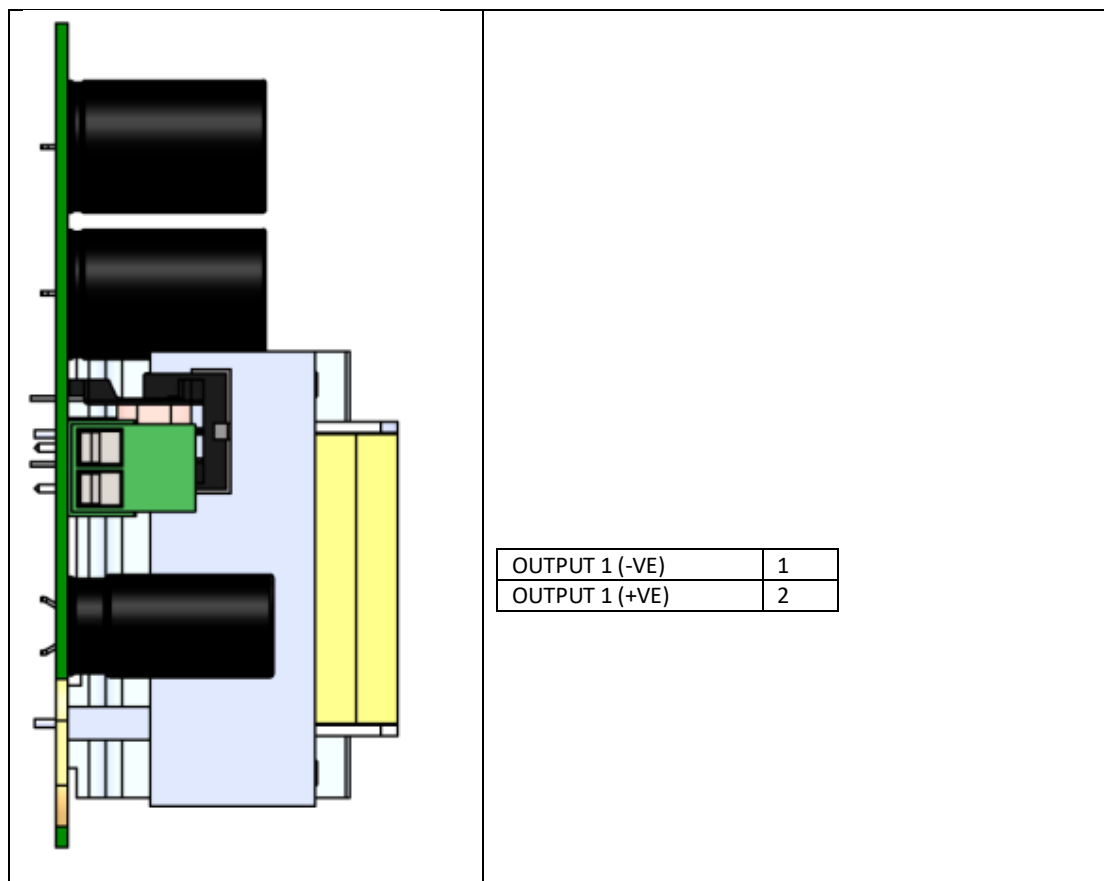

Max Drive Voltage	100V rms @ full load
Distortion	<=0.1%@ 50 Watt
Frequency Response (AS 4428.16)	400 Hz to 10kHz +/- 1dB w.r.t. 1kHz 200 Hz to 12kHz +/- 3dB w.r.t. 1kHz
SNR	>=70%
Speaker Circuit Monitoring	DC, nominal 47kΩ

Applicable Ampac speaker item numbers

Item Number	Description
4113-1006	Ceiling speaker 4" 5W white
4113-1007	Ceiling speaker 4" 5W black
4113-1014 / 54	Ceiling speaker 4" 5W white low profile / grommets
4113-1015 / 55	Ceiling speaker 4" 5W black low profile /grommets
4113-1016 / 56	Ceiling speaker 4" 5W white low profile aluminium grill / grommets
4113-1017 / 57	Ceiling speaker 4" 5W black low profile aluminium grill / grommets
4113-1020	Grey 10W horn speaker
4113-1021	Black 10W horn speaker
4113-1022	Red 10W horn speaker
4113-1023	White 10W horn speaker

4113-1030	Surface mount speaker 4" 5W white
4113-1031	Surface mount speaker 4" 5W black
4113-1034	Surface mount speaker 8" 15W white
4113-1035	Surface mount speaker 8" 15W black
4113-1074	Ceiling speaker 8" 15W low profile white
4113-1075	Ceiling speaker 8" 15W low profile black

The following table details audio load, wire size and length of cable runs.

Calculations are based on a 1 dB of loss (approx. 10V attenuation at the end of the cable run)

Loading	Load Impedance	1.0mm ² Field Wiring	1.5mm ² Field Wiring	2.5mm ² Field Wiring	Maximum Capacitance
25Watt	400Ω	493m	500m	500m*	75nF*
50Watt	200Ω	579m	667m	667m*	100nF*

Max capacitance @50Watt must be below 100nF and max inductance must be below 1mH.

8.6.2 Indicators

The 50Watt amplifier card has one amplifier output status indicator and a general status indicator. See below.

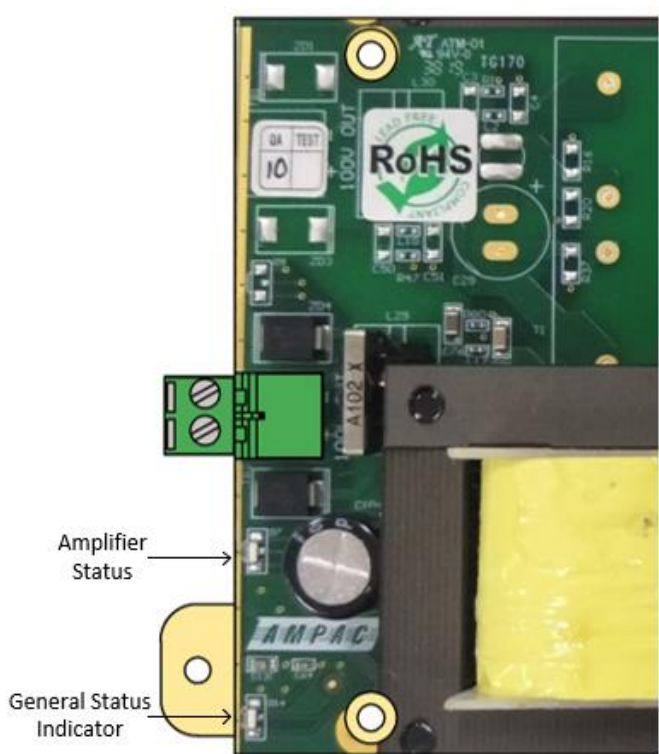
	<p>Amplifier Status Indicator</p> <p>Dual indicators</p> <p>RED: Output is activated (should be red all the tone – showing the test tone is being broadcast)</p> <p>FLASHING AMBER – Fault condition – short circuit / open circuit.</p> <p>General Status Indicator</p> <p>OFF: cards have no power or processor is fault</p> <p>FLASHING GREEN: board is operating, no faults.</p> <p>FLASHING AMBER: board has a fault condition.</p> <p>STEADY AMBER: Not receiving commands from the Distribution CPU</p>
---	--

8.6.3 Field wiring

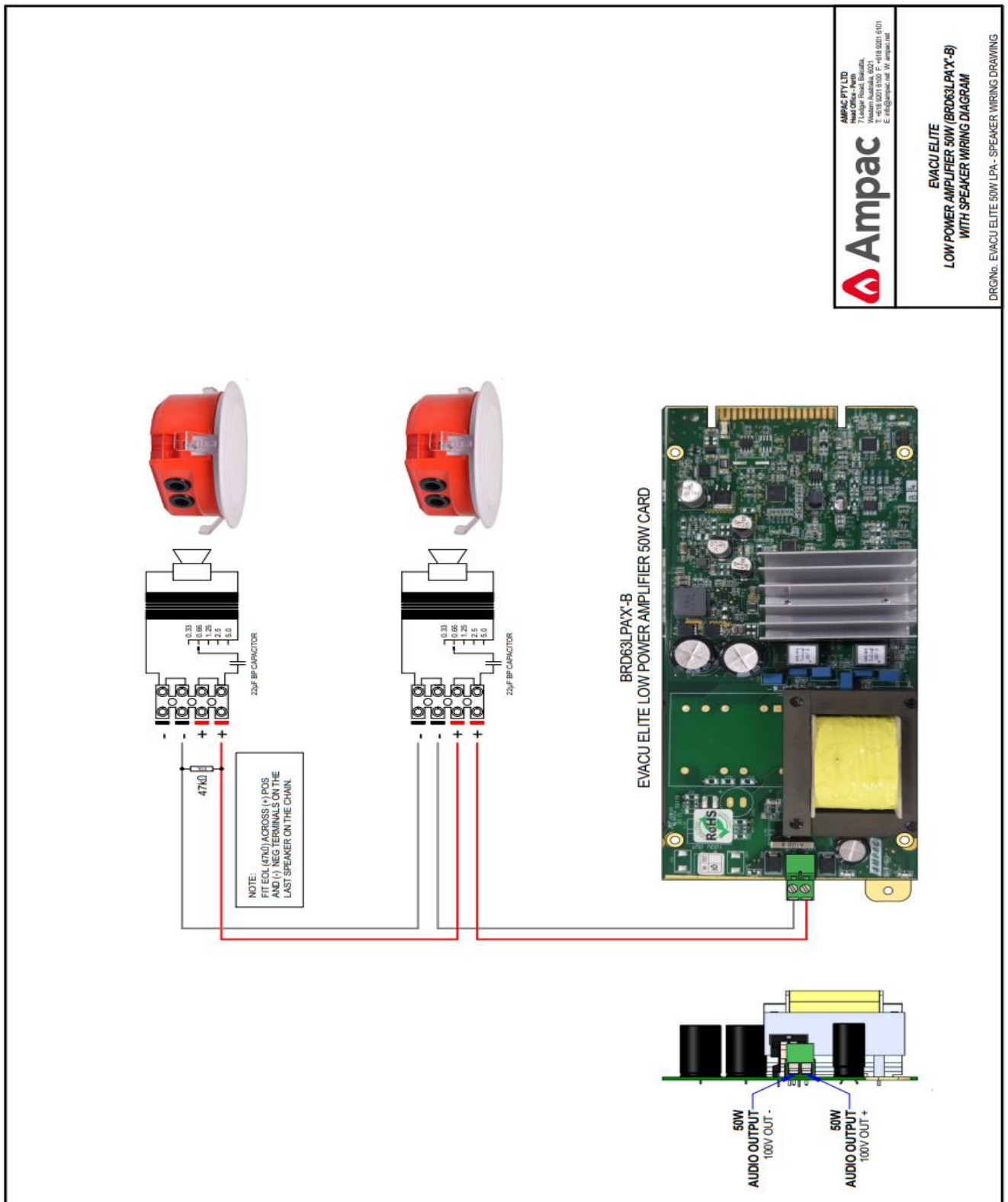

Ampac
 AMPAC PTY LTD
 Trade Office - Perth
 1000000000
 Western Australia, 6001
 T: +618 9201 6100 F: +618 9201 6101
 E: info@ampac.com.au W: www.ampac.com.au

**EVACU ELITE
 LOW POWER AMPLIFIER 50W (BRD63LPAX-B)
 WITH SPEAKER WIRING DIAGRAM**

DRGNo. EVACU ELITE 50W LPA - SPEAKER WIRING DRAWING

Figure 8-5 50Watt amplifier wiring

Refer to section 8.11 for detail on cable terminations and routings.

8.7 150Watt amplifier

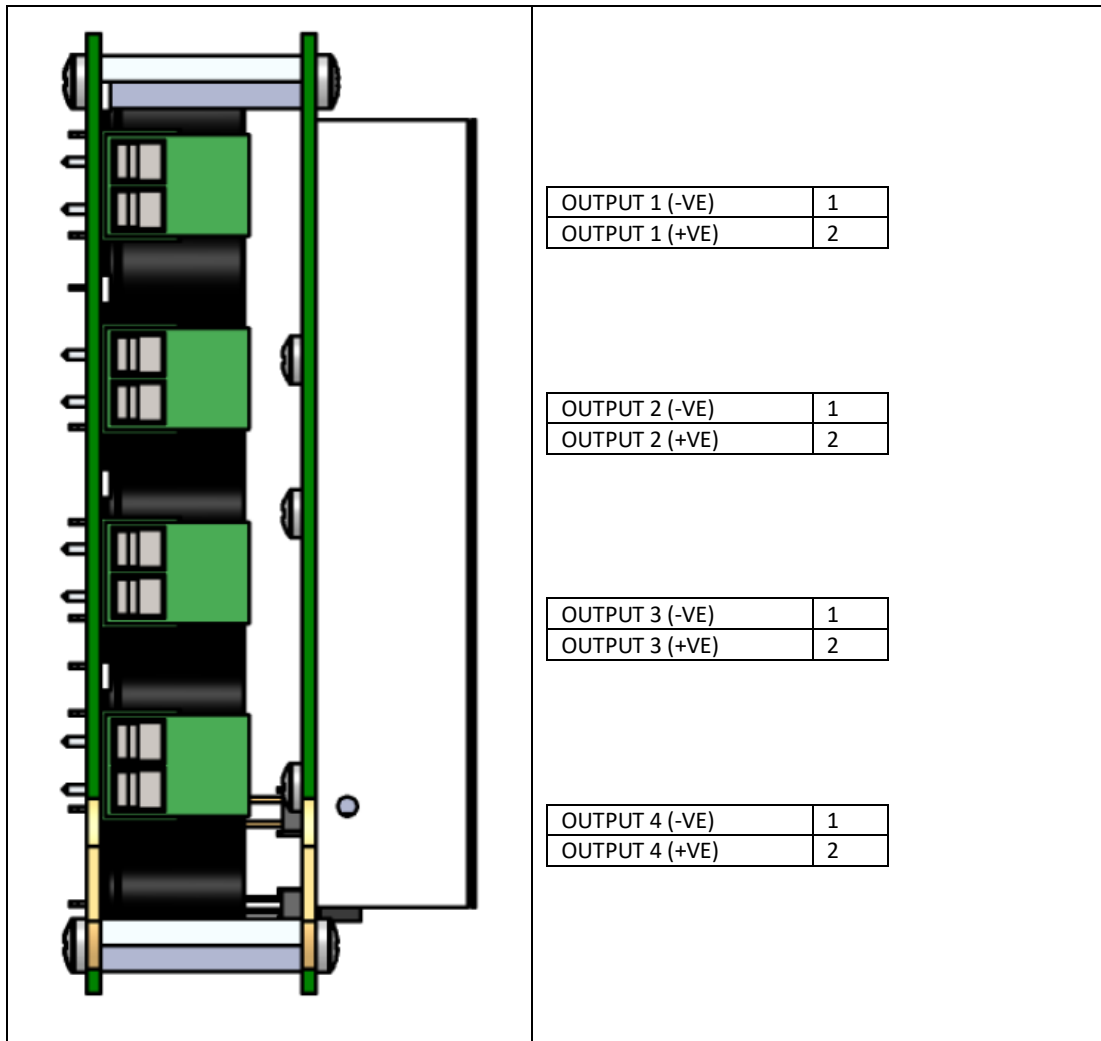

Max Drive Voltage	100V rms @ full load
Distortion	<=0.3%@ 150Watt x1
Frequency Response (AS 4428.16)	300 Hz to 10kHz +/- 1dB w.r.t. 1kHz 150 Hz to 12kHz +/- 3dB w.r.t. 1kHz
SNR	>=70db
Speaker Circuit Monitoring	DC, nominal 47kΩ

Note If using 4 split O/Ps and each split exceeds >500M distance, Talk to Ampac about our cable calculator. When using more splits, overall circuit capacitance limits the distances (based on 4 x connected loads)

Loading	Wattage Load	1.0mm ² Field Wiring	1.5mm ² Field Wiring	2.5mm ² Field Wiring	Maximum Capacitance
150 Watt One feed (O/P 1)	150W 120W	193 241	297 371	528 660	200nF* 200nF
Load "examples"					
Split 2 - O/P 2	75W MAX	386	594	667	100nF
Split 3 - O/P 3	40W MAX	658	667	667	66.66nF
Spilt 4 - O/P 4	30W MAX	658	667	667	50nF

8.7.1 Field wiring

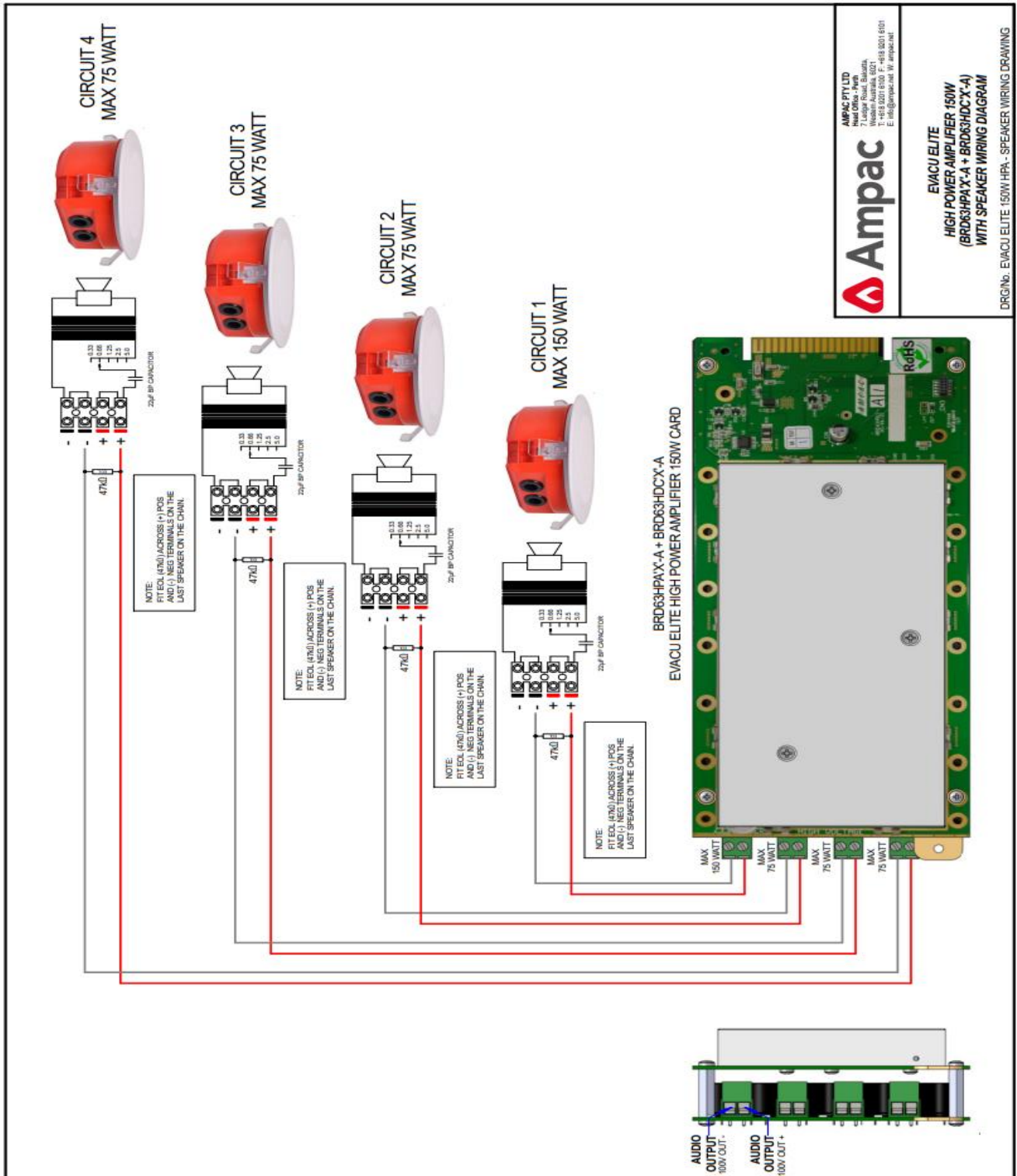
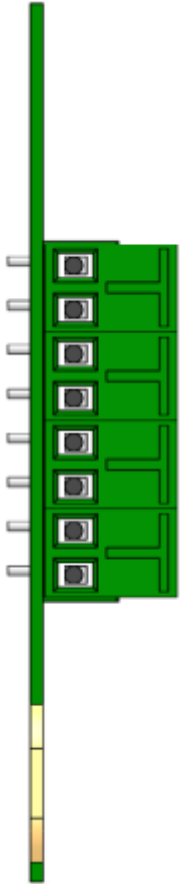

Figure 8-6 150Watt amplifier wiring

8.8 Quad radial EIS line card (ILC)

8.8.1 Connections

Following table details the field connections for the Quad radial EIS line card.

	HANDSET 1	1
	HANDSET 1	2
	HANDSET 2	3
	HANDSET 2	4
	HANDSET 3	5
	HANDSET 3	6
	HANDSET 4	7
	HANDSET 4	8

WIP handset 1, 2, 3 and 4	Inputs for Ampac EvacU ^{ELITE} radial WIP handsets (polarity insensitive). Up to 2 Ampac MCPs can be connected to each handset. Cabling size recommended is 1.5mm ² 2 Core, Max length 1000m, line impedance 600Ω, bandwidth 3K4 Hz.
---------------------------	--

8.8.2 Indicators

The Quad radial EIS line card has one status indicator per handset output (4) and a general status indicator. See below.

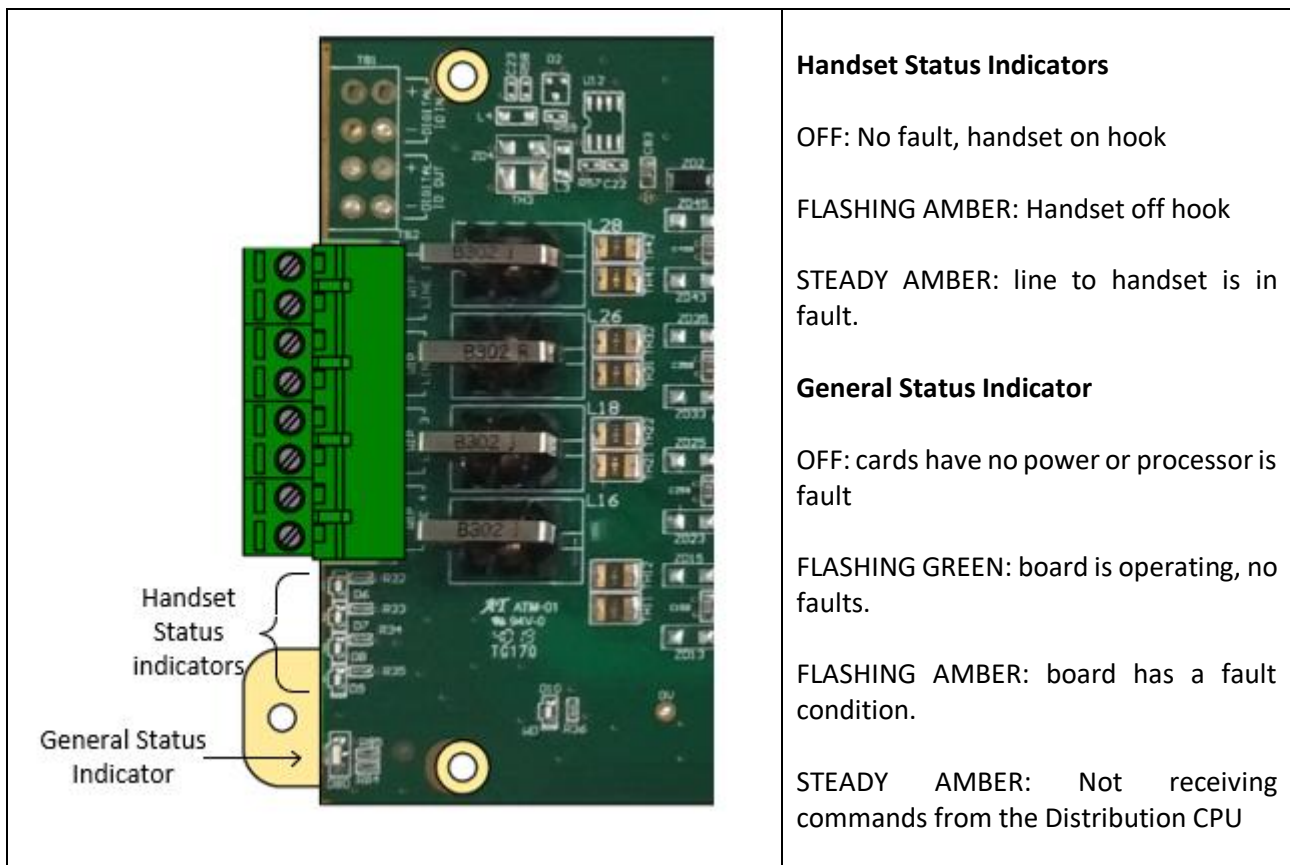

Handset Status Indicators

OFF: No fault, handset on hook

FLASHING AMBER: Handset off hook

STEADY AMBER: line to handset is in fault.

General Status Indicator

OFF: cards have no power or processor is fault

FLASHING GREEN: board is operating, no faults.

FLASHING AMBER: board has a fault condition.

STEADY AMBER: Not receiving commands from the Distribution CPU

8.8.3 Field wiring

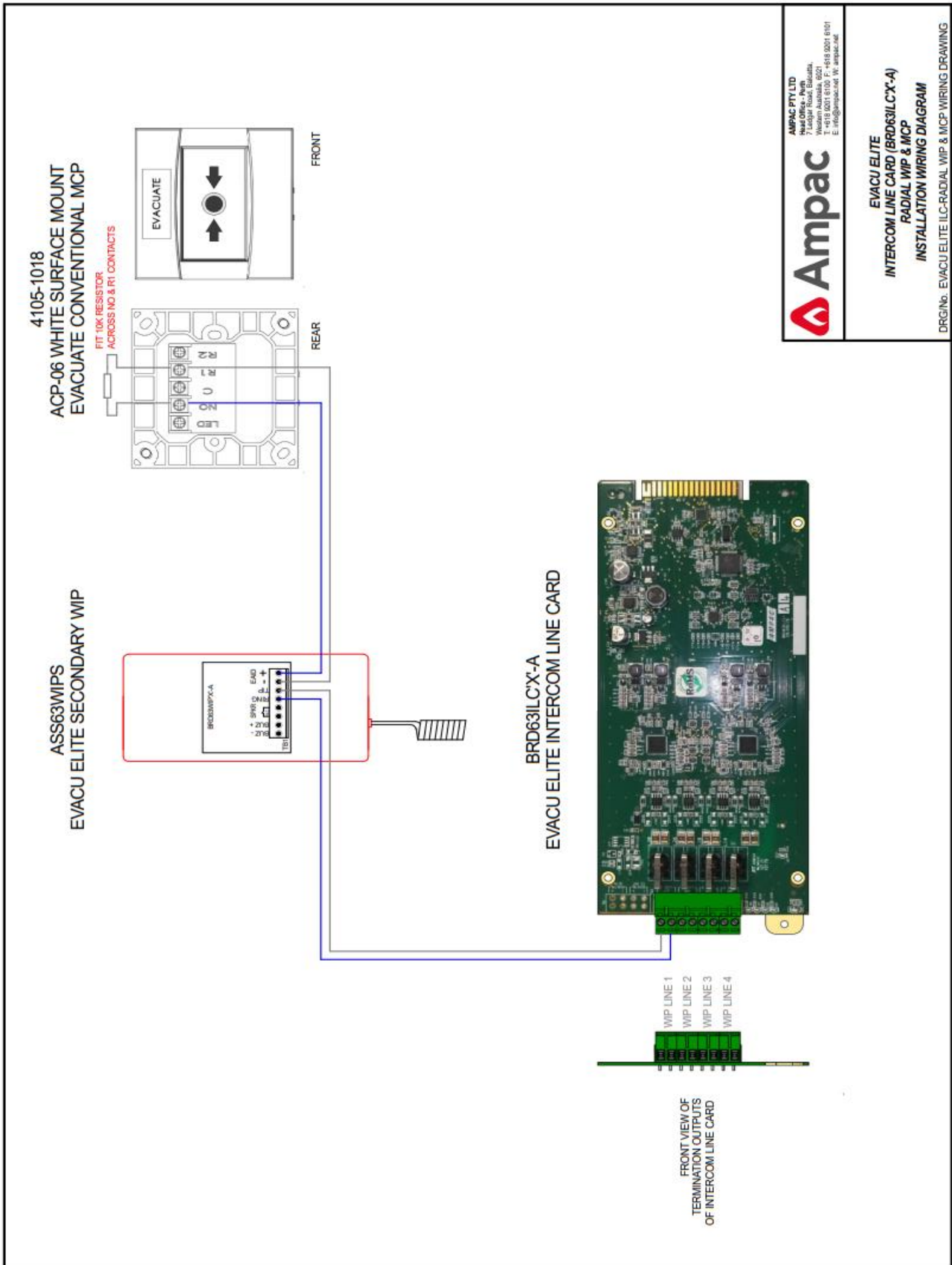
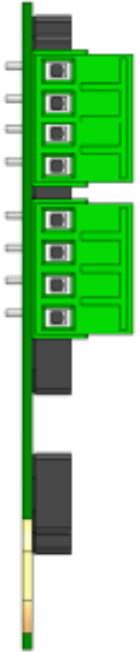

Figure 8-7 Quad radial EIS wiring

8.9 Dual loop EIS line card (LILC)

8.9.1 Connections

Following table details the field connections for the dual loop EIS line card.

	LOOP 1 OUT +	1	
	LOOP 1 OUT -	2	
	LOOP 1 IN +	3	
	LOOP 1 IN -	3	
	LOOP 2 OUT +	1	
	LOOP 2 OUT -	2	
	LOOP 2 IN +	3	
	LOOP 2 IN -	4	

LOOP1/2 IN/OUT	Inputs for Ampac EvacU ^{ELITE} Loop WIP handsets. Up to 2 Ampac MCPs can be connected to each handset. Max of 20 handsets per loop. Cabling size recommended 1.5mm ² 2 core UTP. Maximum loop length 1000m
----------------	--

8.9.2 Indicators

The Dual loop EIS line card has one status indicator per handset output (4) and a general status indicator. See below.

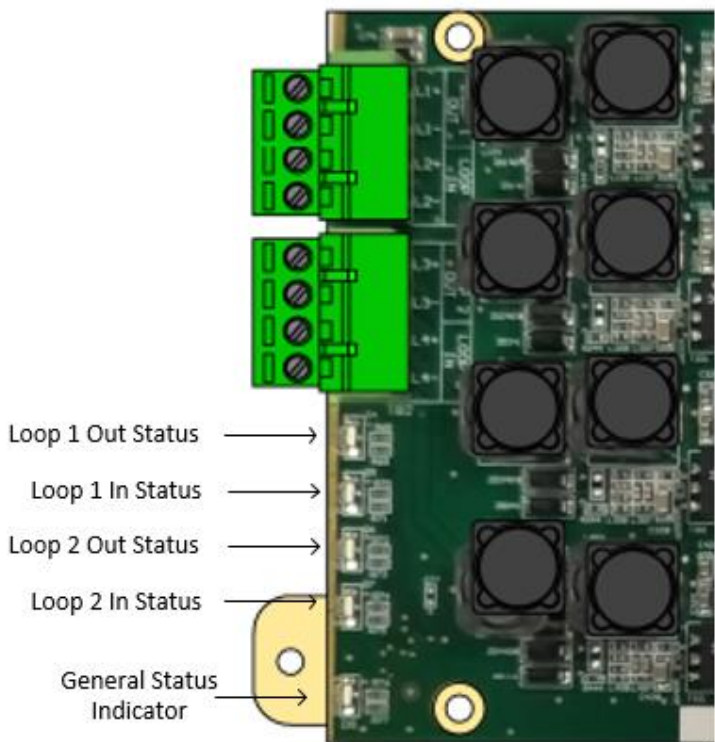
	<p>Loop Status Indicators</p> <p>AMBER: Fault – short, open, overload</p> <p>RED: power is present</p> <p>In redundant mode – only the Out port will be active under normal conditions.</p> <p>General Status Indicator</p> <p>OFF: cards have no power or processor is fault</p> <p>FLASHING GREEN: board is operating, no faults.</p> <p>FLASHING AMBER: board has a fault condition.</p> <p>STEADY AMBER: Not receiving commands from the Distribution CPU</p>
--	---

8.9.3 Field wiring - Use of Ferrites on each Loop WIP card

Note: Two x MIS3019 ferrite core items are packed with each LOOP WIP card (**6350-LILC**). It is necessary for the installer to connect the ferrites on each loop circuit as shown.

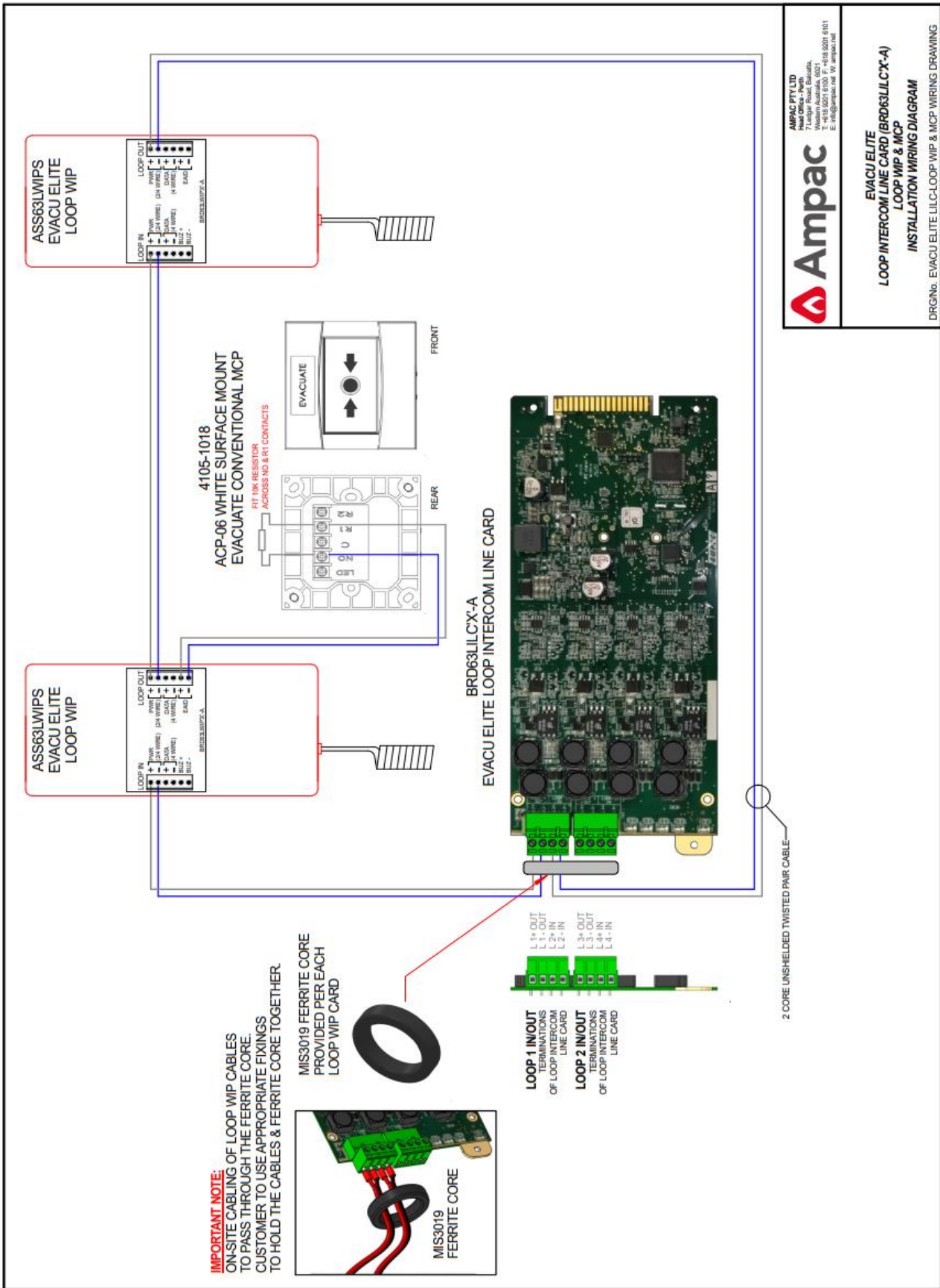

Figure 8-8 Dual loop EIS wiring

8.10 PAIC Public Address Interface Card

PAIC is a **de populated** network interface card hence looks similar. The *SFP port connectors are not configured when used as PAIC.

8.10.1 PAIC -Network Switch Card Indications

Following details, the LED indications for the PAIC (aka **Network Switch Card**)

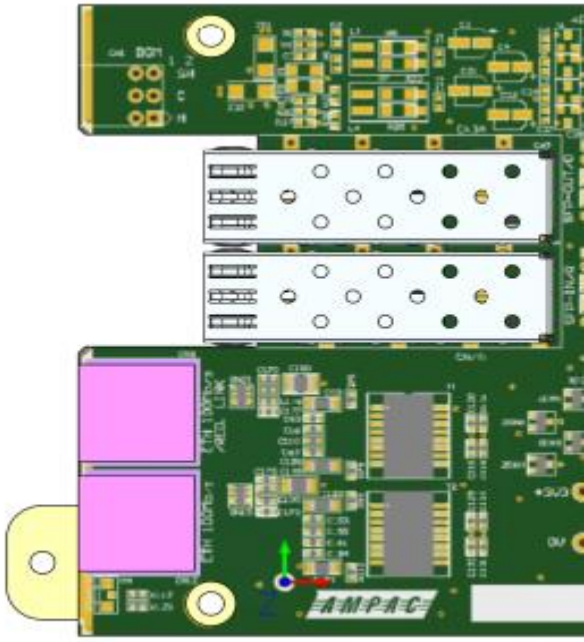
	<p>General Status Indicator</p> <p>OFF: cards have no power or processor is fault</p> <p>FLASHING GREEN: board is operating, no faults.</p> <p>FLASHING AMBER: board has a fault condition.</p> <p>STEADY AMBER: Not receiving commands from the Distribution CPU</p>
--	--

8.10.2 PAIC -Network Switch Card Connections

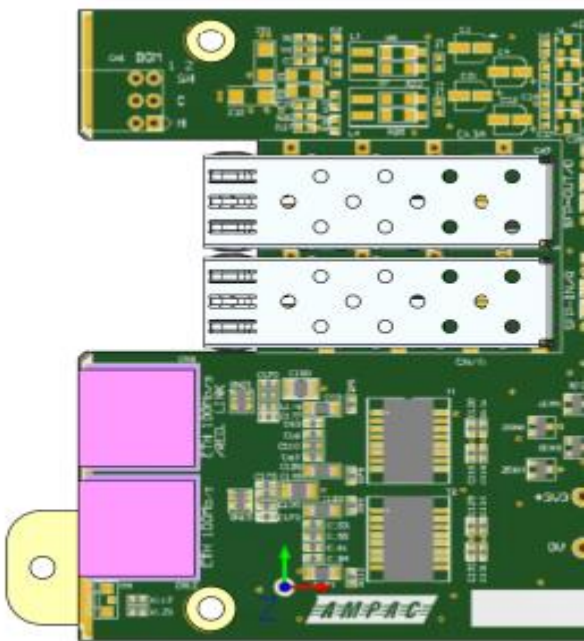
	<p>*SFP 1 Port 1</p> <p>*SFP 2 Port 2</p> <p>ETHERNET 1 (RJ45) Port 3 Connection to Bosch Praesensa</p> <p>ETHERNET 2 (RJ45) Port 4</p>
---	--

Ethernet Ports 3 or 4 can be used to connect and configure to the Bosch Praesensa System Controller

8.10.3 PAIC Interface CSIRO Application Note

An application note created by Bosch has been submitted to CSIRO for approval.

“Interfacing Praesensa & Ampac EvacUElite EWS Panel for AS4428-16 Compliance - Draft

8.10.4 EvacUElite to Bosch Praesensa Connections

The following page details the connections.

The Bosch System Controller connects to each Bosch PA system component respectively and PAIC as illustrated.

The Bosch Multifunction power supply connects to each Bosch PA system component.

Other references:

Refer Bosch Praesensa CSIRO Application Note

Bosch Praesensa installation manual

Bosch Praesensa configuration Manuals

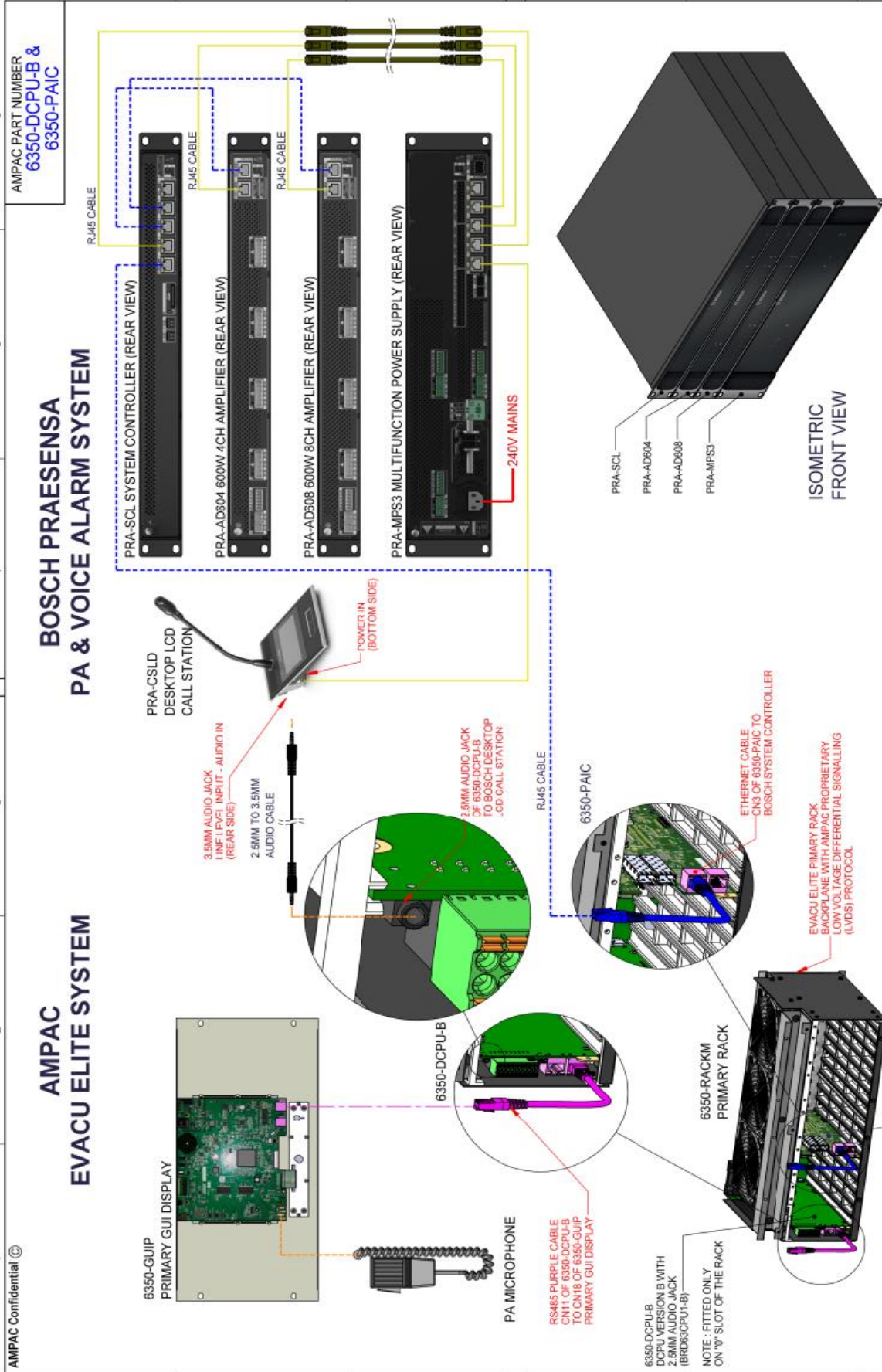

		AMPAC PTY LTD 7 Ludwig Road, Bacalla, Western Australia 6021 E: info@ampac.com.au P: 08 9401 6101 F: 08 9401 6101	
DRN	PT	DATE	SCALE
14/08/23	JR	14/08/23	1:6
TOLERANCES UNLESS OTHERWISE NOTED WHOLE NUMBERS ±0.5 1 DECIMAL PLACE ±0.2 2 DECIMAL PLACES ±0.1 ANGLES ±0.5°		SHEET 1 OF 1 DRAWING No. 6350-DCPU-B & 6350-PAIC INSTALL GUIDE	
DRAFTING STANDARD AS 1100:1992		DIMENSIONS IN MILLIMETRES	
REV	DATE	PT	ZONE
0	14/08/23	PT	
REV	DATE	DRAWN	REVISION HISTORY

8.11 Network Interface Card

8.11.1 Connectors

Following table details the field connections for the network interface card.

The Port Numbers are referred to in the NIC screen when detailing the status of the network loop topology.

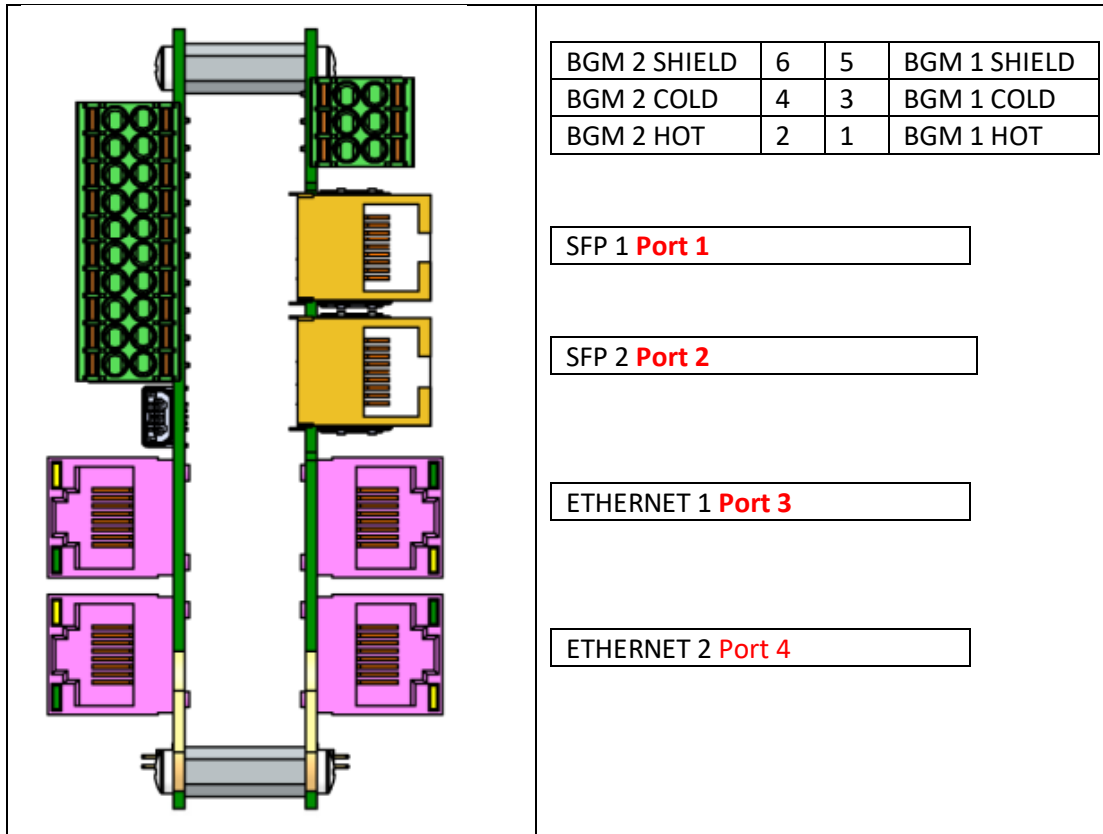

BGM connection notes

In the Windows programming tool screen (shown below)

BGM 1 Connection = Input 1 ID

BGM 2 Connection = Input 2 ID

BGM source numbering guide.

A BGM source number may be applied (configured) to each amplifier respectively in the system.

When a BGM source is distributed to multiple panels only use **Source ID numbers 1 & 2** inside the input field box

When a BGM source is distributed through local panel racks only use source numbers 100,101,102 and so on if you have multiple BGM sources.

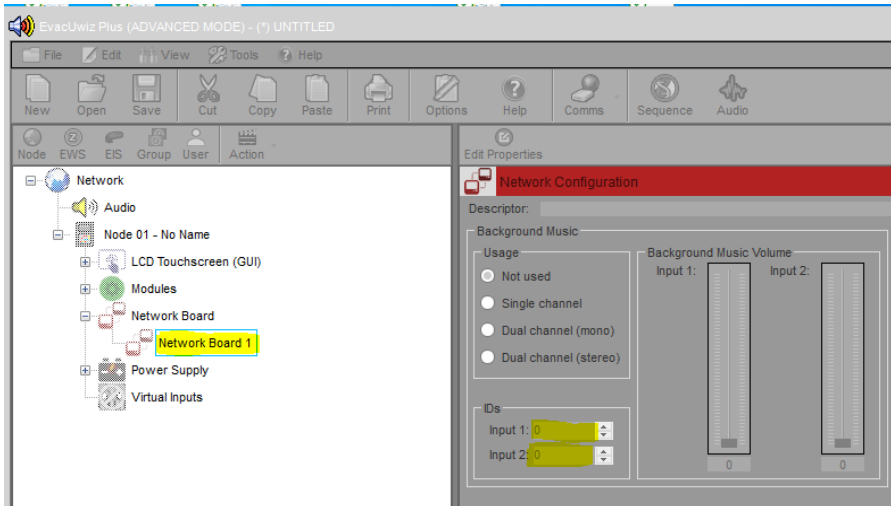

8.11.2 Understanding EvacUElite Network fault conditions

The goal is to understand all **in / out** connections between each Node respectively. How the network of panels is cabled. What types of SFP modules are fitted in each node (If any)

Are any of the ports 3 & 4 used by connecting ethernet cables (Cat5 or Cat6e) between ‘side by side’ panel nodes?

Looking at the **Nodes/ NIC** screen on the **Primary GUI** (User interface)

Link OK means the network connection is good.

Link Down means the node is not seen or recognised.

Loop Break means no port is working. Indicating cabling or connection issues

See Drawing on Page 110 showing the respective **Port Numbers**

Port 1 UP means port number 1 connection is good.

Port 2 UP means port number 2 connection is good.

Port 3 UP means port number 3 connection is good.

Port 4 UP means port number 4 connection is good.

Review Ports 1-4 status in the NIC screen Determine which ports **are used in your network** application.

Determine if any port number is ‘Port down’ which is **opposite of Port Up**

Port down means a comms signal is missing.

Possible Causes

1. Check for a cabling issue between the **port up** and corresponding ‘**port down**’
2. A Faulty SFP module.
3. Check visual LED indications on the SFP.
4. A faulty Breakout boards.
5. Cabling polarity from Metanoia VDSL Copper SFP modules to the breakout board.
6. **O & R modules** must be fitted into the **correct ports as illustrated on each network drawing**
7. The polarity of the network connections **out to in**, throughout the network connections is imperative.

Possible Causes continued

Visually cross check the factory wiring between the **SFP to the breakout** remains the correct polarity as per the schematic (not crossed over) in the event of network connection issues.

SFP Type VDSL Copper Metanoia modules

There are LED indicators **on the VDSL metanoia modules** that can be seen visually when they are plugged in. They are quite deep into the SFP sockets.

Visual indication aids on the Metanoia modules

when functioning OK ...

In the O version - No LED on Top.

It has a green flashing LED on the bottom.

In the R version - Steady Amber LED on top

It has a green flashing LED on the bottom.

8.11.3 Indications

The network interface card has a general status indicator. See below.

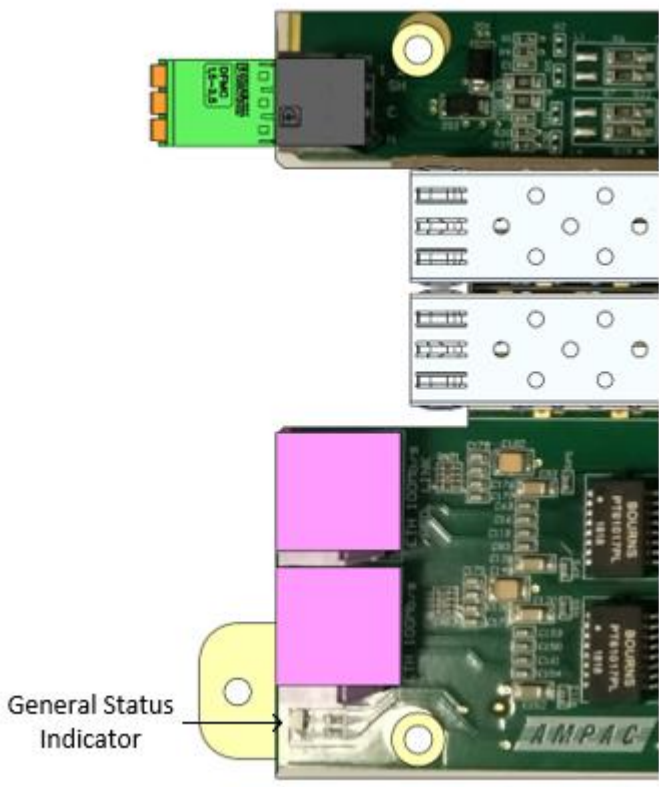
 <p>General Status Indicator</p>	<p>General Status Indicator</p> <p>OFF: cards have no power or processor is fault</p> <p>FLASHING GREEN: board is operating, no faults.</p> <p>FLASHING AMBER: board has a fault condition.</p> <p>STEADY AMBER: Not receiving commands from the Distribution CPU</p>
--	--

8.11.4 Setting the node address

 <p data-bbox="699 600 884 629">NODE ADDRESS</p>	<p data-bbox="944 277 1118 306">Node Address</p> <p data-bbox="944 347 1430 416">The DIP switch shown is used to set the node address.</p> <p data-bbox="944 456 1430 526">The LSB of the address is the left switch (markings on the overlay of the PCB)</p>
--	--

8.11.5 Field wiring

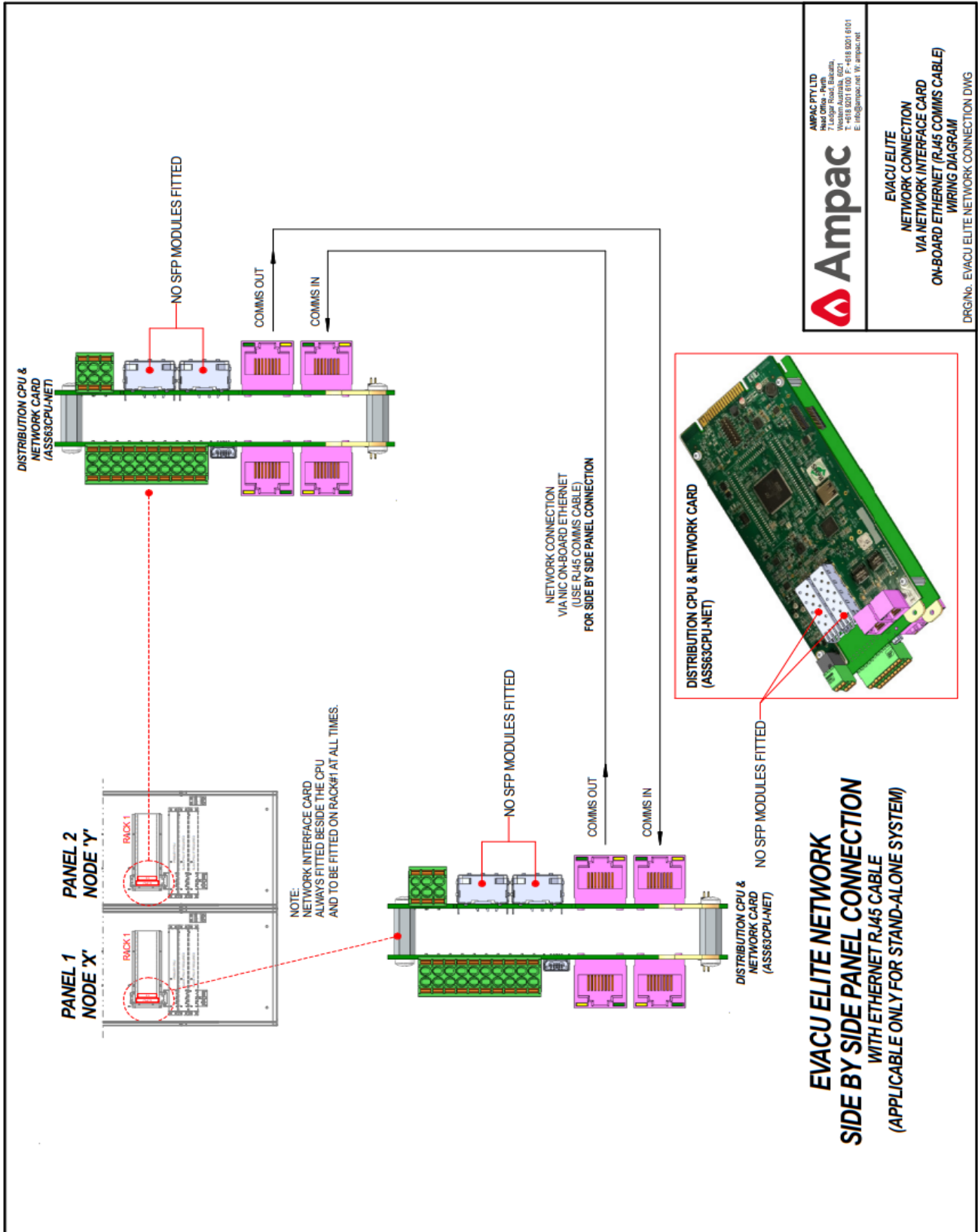

Figure 8-9 Network wiring - side by side cabinets

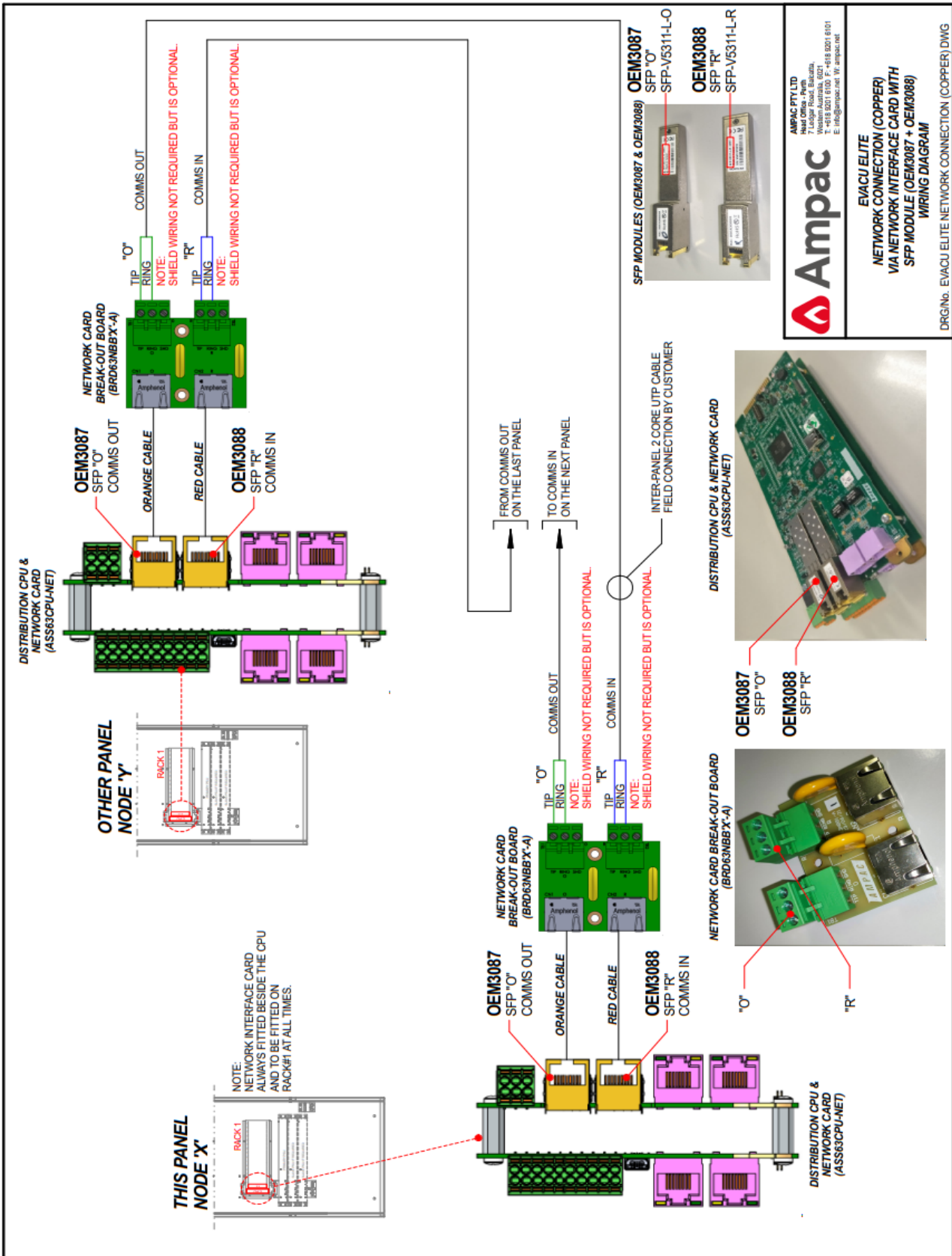
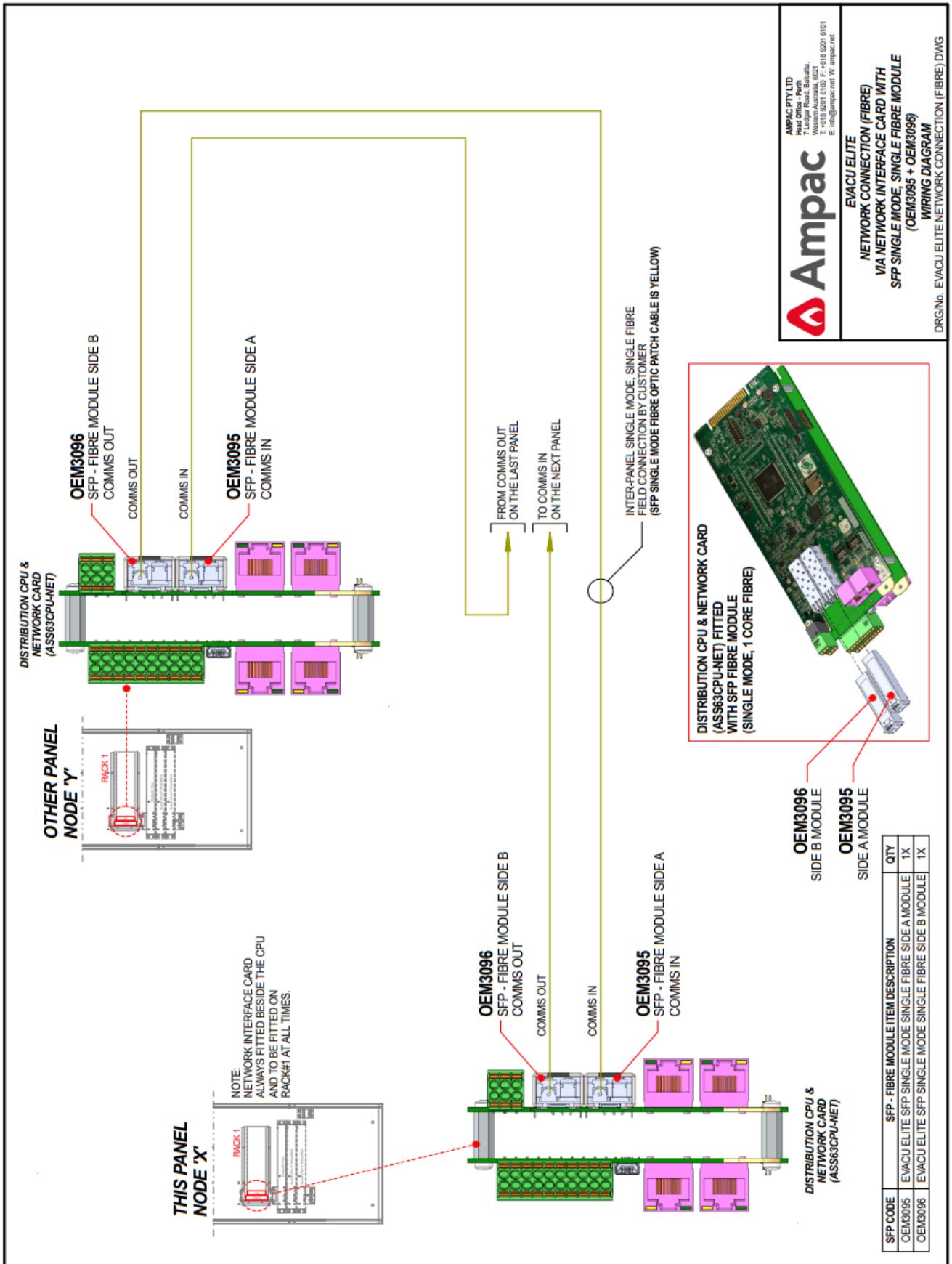

Figure 8-10 Network wiring - 2 core copper.



AMPAC PTY LTD
 Head Office - Perth
 7 Leagar Road, Balcatta,
 Western Australia 6100
 T: +618 9201 8100 F: +618 9201 8101
 E: info@ampac.net W: ampac.net

EVACU ELITE
NETWORK CONNECTION (FIBRE)
VIA NETWORK INTERFACE CARD WITH
SFP SINGLE MODE, SINGLE FIBRE MODULE
(OEM3095 + OEM3096)
WIRING DIAGRAM

DRGNo. EVACU ELITE NETWORK CONNECTION (FIBRE) DWG

Figure 8-11 Network wiring – Single mode, single fibre

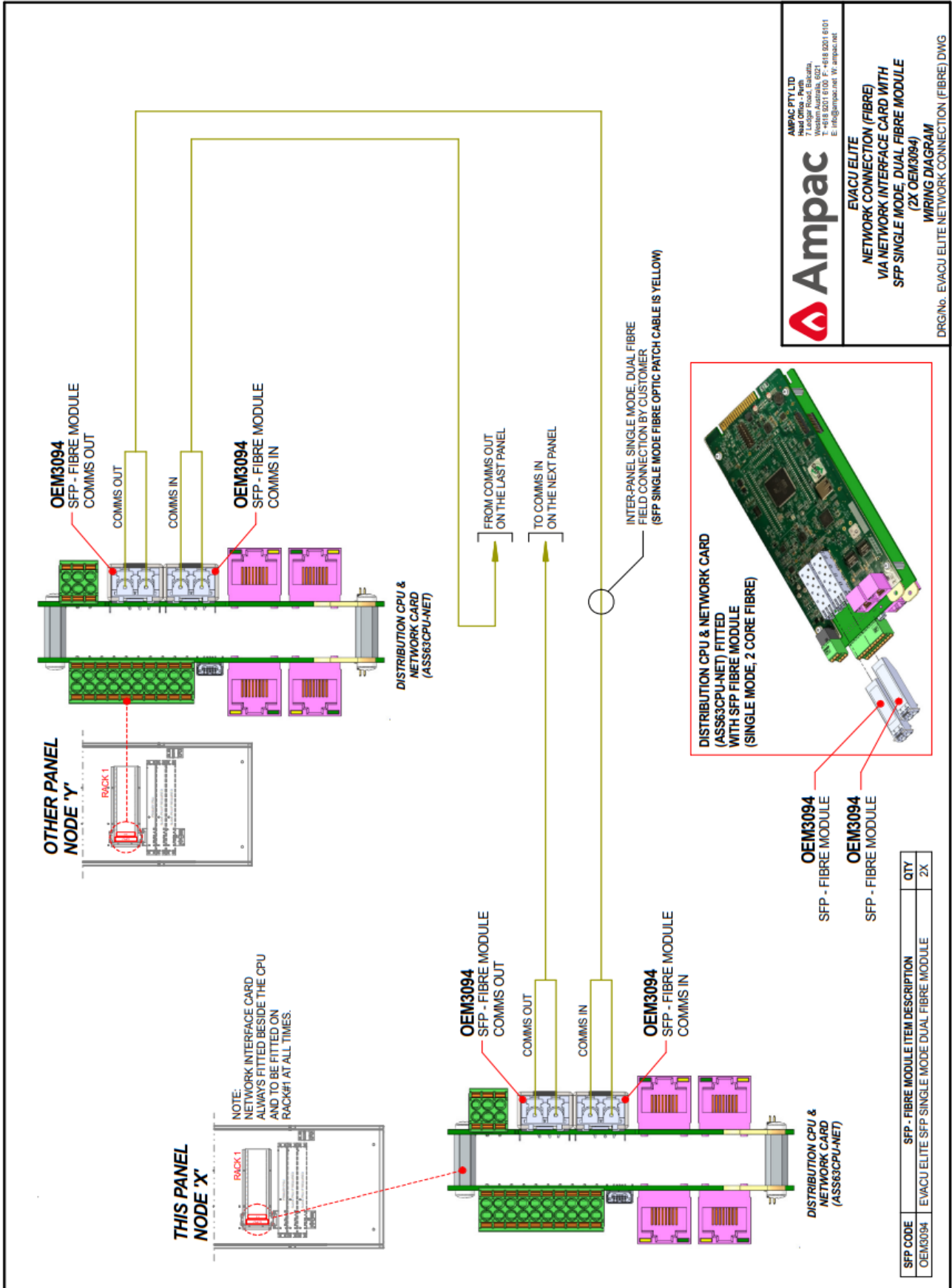

AMPAQ CITY LTD
Head Office - Perth
7 Ledger Road, Balcatta,
Western Australia 6100
E: info@ampac.net W: ampac.net

EVACU ELITE NETWORK CONNECTION (FIBRE) VIA NETWORK INTERFACE CARD WITH SFP SINGLE MODE, DUAL FIBRE MODULE (2X OEM3094) WIRING DIAGRAM

DRG.No. EVACU ELITE NETWORK CONNECTION (FIBRE) DWG

Figure 8-12 Network wiring - Single mode, dual fibre

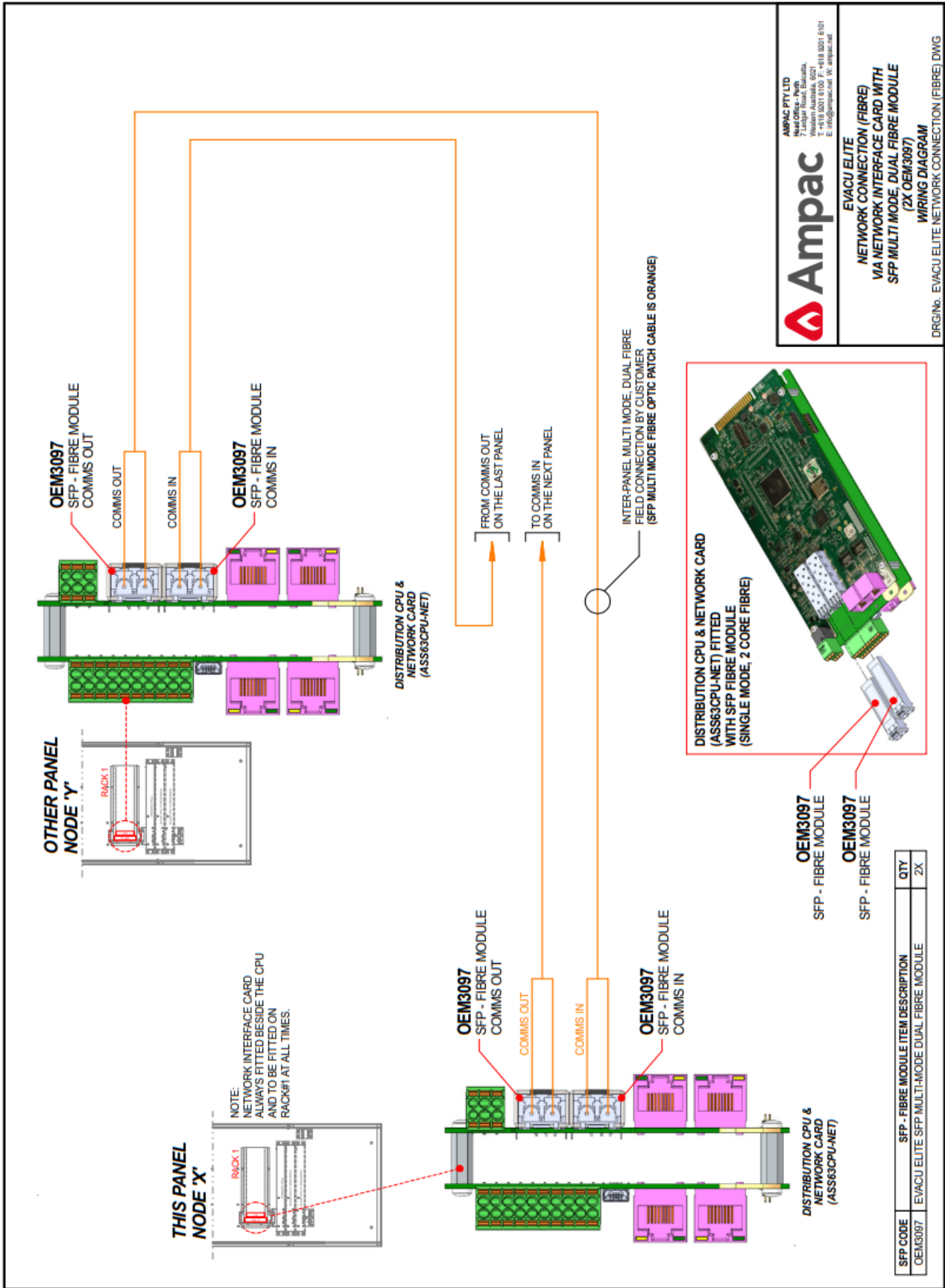

Ampac

AMPAC PTY LTD
 Head Office - Perth
 1000/1001 North Street
 Wembley, Australia 6007
 T: +618 9201 8100 F: +618 9201 8101
 E: info@ampac.net.au W: ampac.net.au

EVACU ELITE
NETWORK CONNECTION (FIBRE)
VIA NETWORK INTERFACE CARD WITH
SFP MULTI-MODE, DUAL FIBRE MODULE
(2X OEM3097)
WIRING DIAGRAM

DRG No. EVACU ELITE NETWORK CONNECTION (FIBRE) DWG

Figure 8-13 Network wiring - Multi mode dual fibre

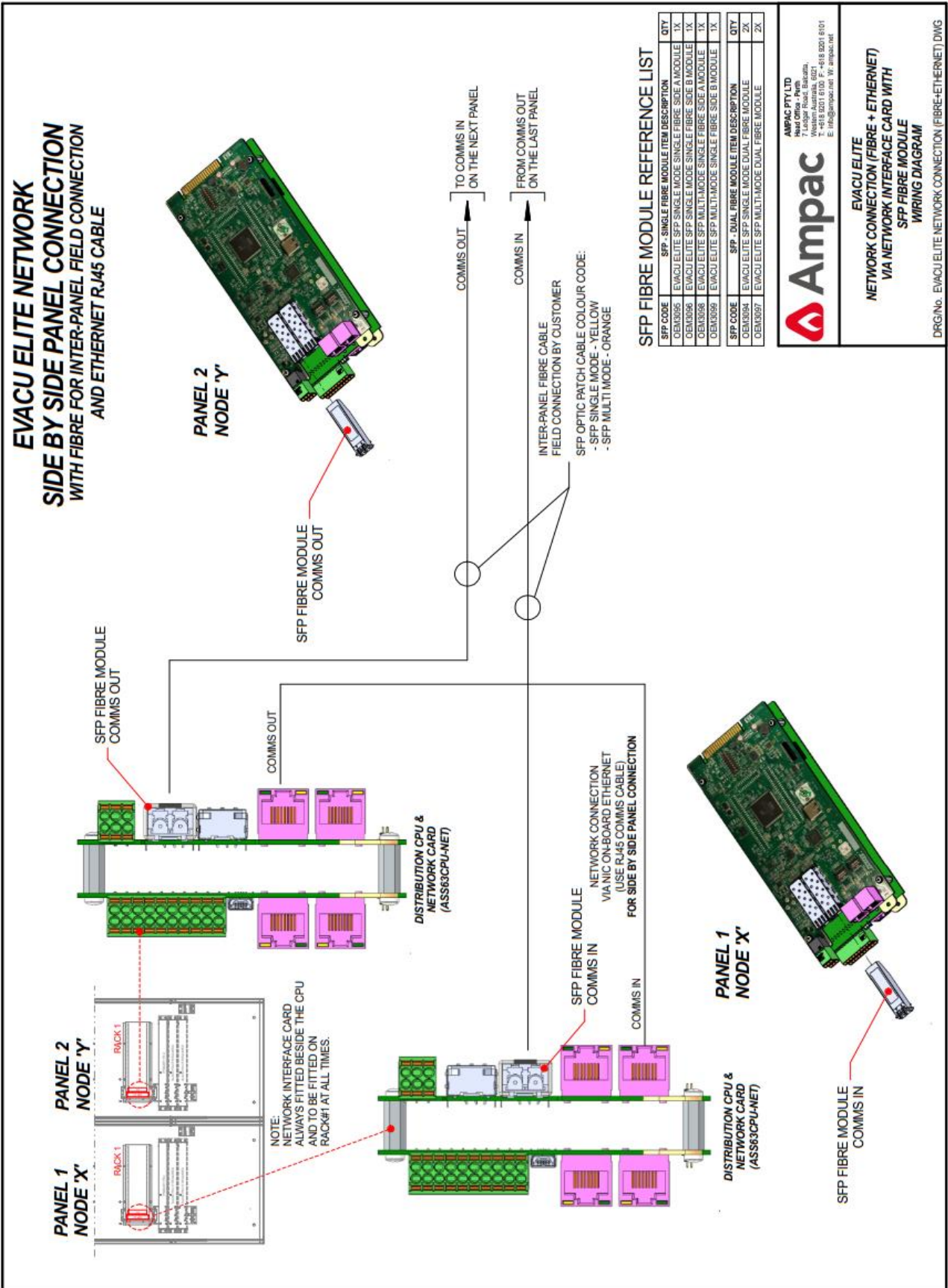

Figure 8-14 Network wiring – Mixed - Fibre

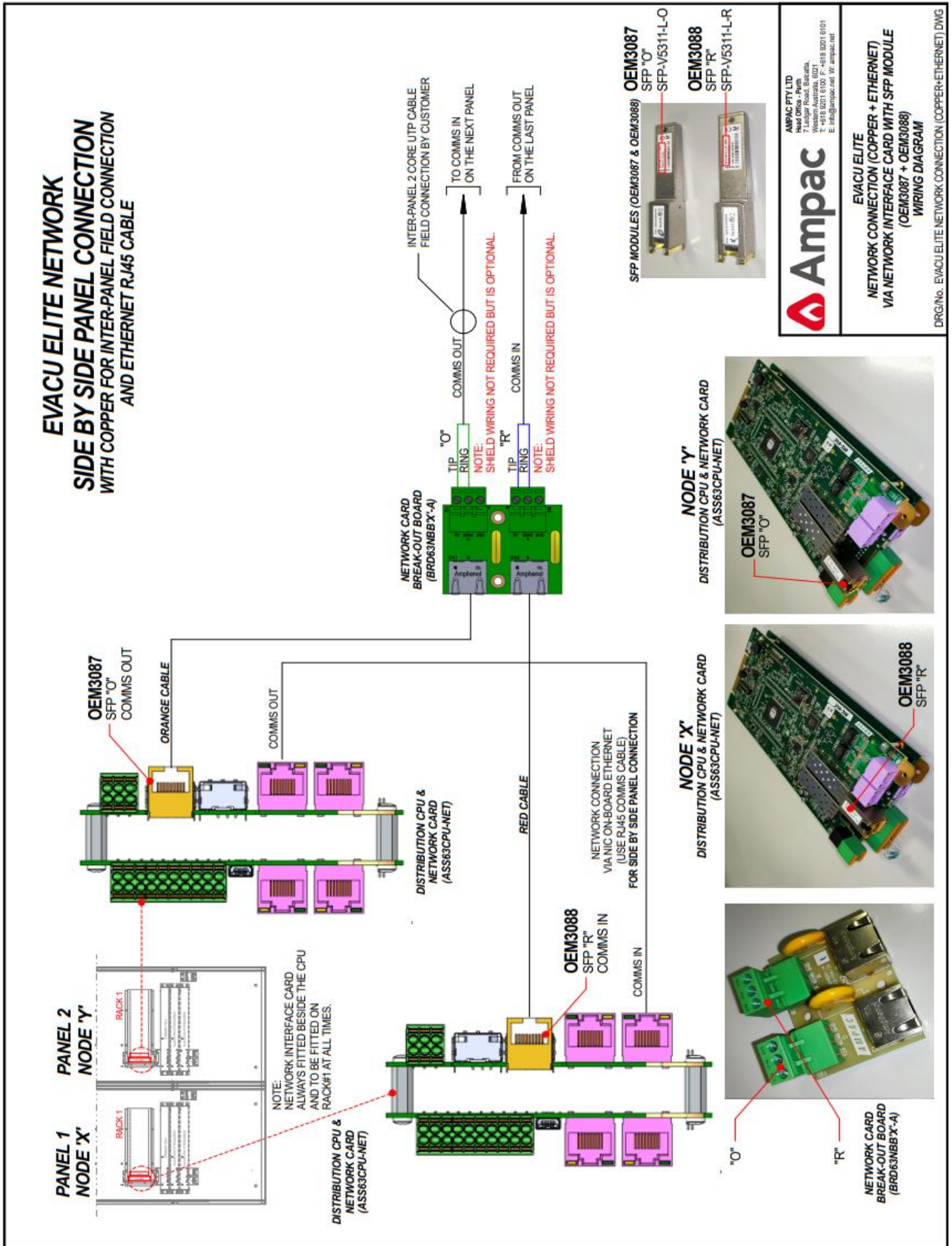

Figure 8-15 Networking wiring – Mixed - VDSL

8.12 Cable Terminations and Routing

Both AS 4428.4 And AS 4428.16 require all internal cable terminations and cable routings to comply with the relevant clauses of AS/NZS3100 and AS/CA S009.

To comply with the above, there must be 50mm separation between ELV and LV wiring.

The only LV wiring with the cabinet is the 100V speaker wiring. It is recommended that all speaker wiring is terminated using ferrules – which suit the gauge of the cable being used.

Speaker wiring should conform to one of the following standards: AS/CA S008, As/NZS 3191, AS/NZS 5000.1, AS/NZS 3808 or marked with VW-1.

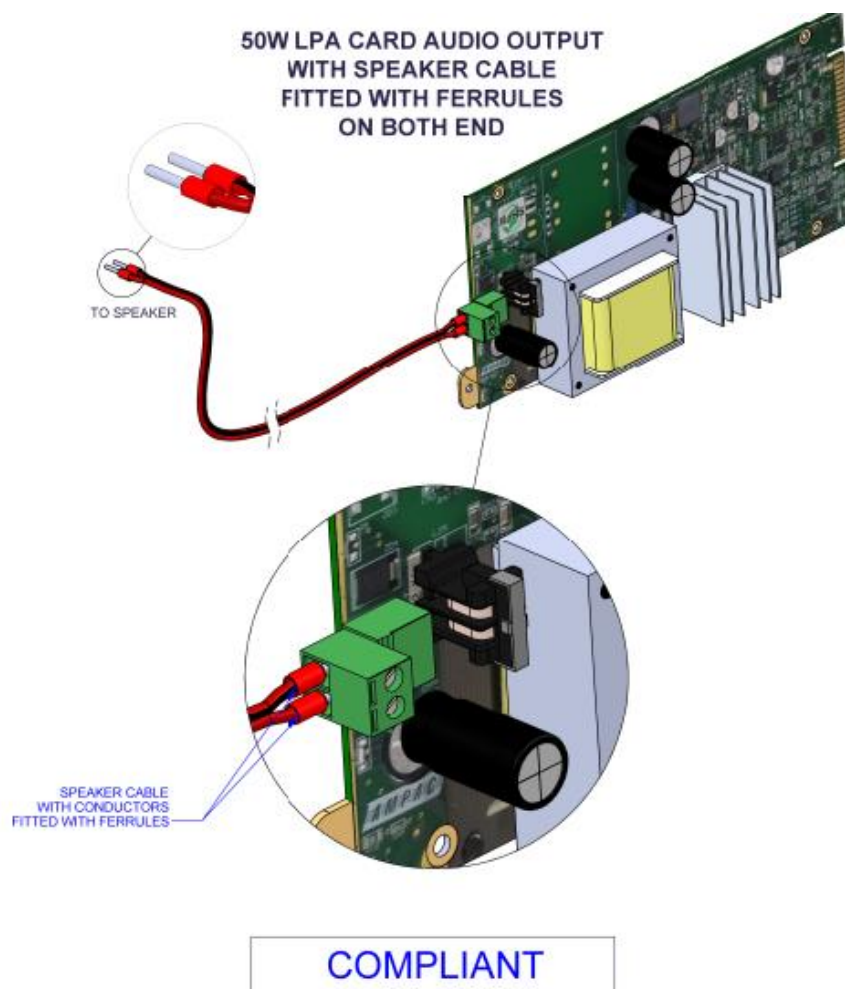

Figure 8-16 Correct speaker wiring termination.

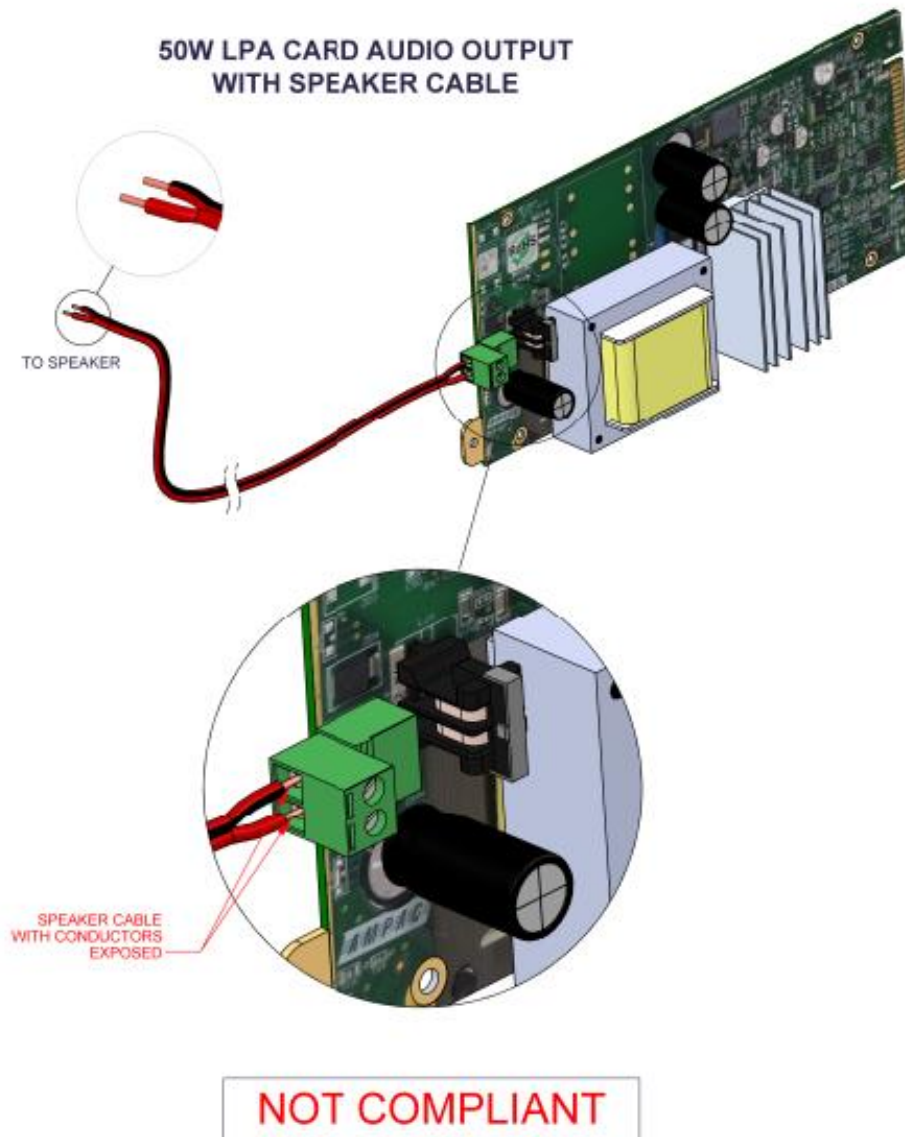

Figure 8-17 Incorrect speaker wiring termination.

All speaker wiring should be routed away from the other ELV wiring.

Refer to figure 8-17 and 8-18 for guidelines on routing the field wiring into the cabinet.

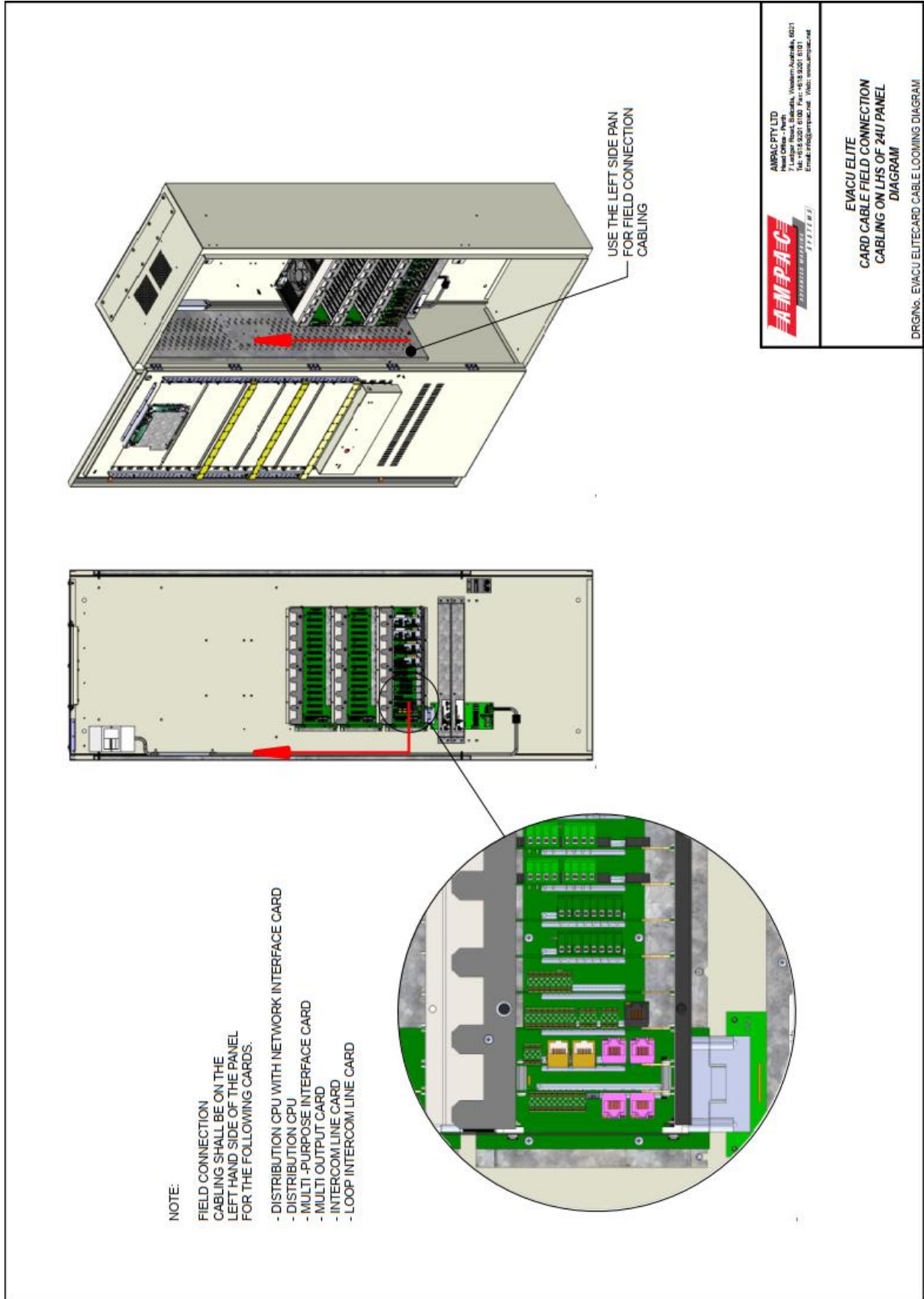

Figure 8-18 Cable routing - left hand side

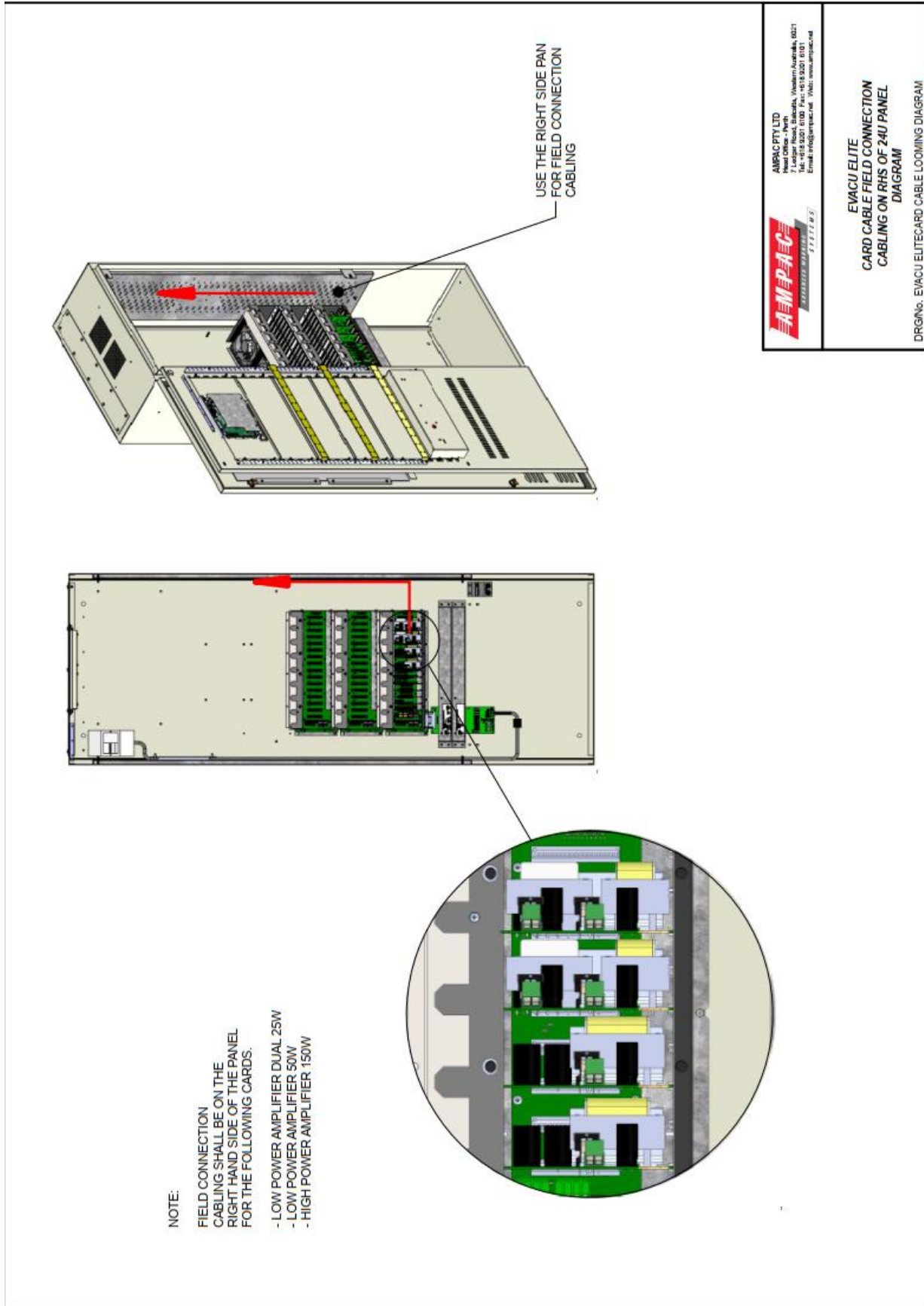

Figure 8-19 Cable routing - right hand side

9 Maintenance

The EvacU^{Elite} does not require any regular maintenance / servicing.

If batteries are provided as the standby power source, then the batteries shall be maintained as per the manufacturer's recommendations.

It is highly recommended that any faults reported by the EvacU^{Elite} are rectified in a timely manner.

There may be a regulatory requirement (for example AS 1851) to carry out periodic routine servicing of emergency warning and intercom equipment. This servicing usually consists of check the system for correct operation, checking the condition of the standby power source (batteries) and ensuring there has been no changes to the building / site that could affect the correct operation.

10 Specification

10.1 General

	24U Floor Mount Enclosure	13U Wall / Floor Mount Enclosure
Dimensions	1800 (H) x 650 (W) x 380 (D)	900 (H) x 650 (W) x 380 (D)
External operating voltage	230VAC (operating range 195 to 253VAC)	
Max No. of emergency zones	512	
Max No. of WIP handsets	1024	
Max No. of nodes	64	
Max No. of alarm inputs	512	
Max No. of RPCs per node	8(100m CAT5/6 Daisy chain)	
Amplifier sizes	Dual 25 Watt	
	50 Watt	
	150 Watt with integrated 4-way splitter	
Graphical user interfaces	8	4
Universal Rack Frame	5	2
Temperature	-5°C to +50°C	
Humidity	5% to 95% non-condensing	
IP Rating	24U and 13U cabinets are IP30 Rated with outer door locked.	

(16U (1200H x 650 x 380) is also proposed for overseas CIE.

10.2 Graphical user interface

Parameter	Detail
Display screen	9-inch TFT LCD 800x480 with LED backlight and resistive touch screen
Microphone	600Ω with capsule monitoring
Emergency intercom handset	Electret capsule with 150Ω speaker
USB support	Host (USB memory stick) and Device (mini-USB) connection
SD Card support	Yes
HLI (to 3 rd party FDCIE/Graphics)	1 x RJ45 connector with isolated RS 485
Ethernet support	2 x RJ45 with proprietary power and transformer isolation (not for general use)
Current Consumption	0.185 amps (quiescent) and 0.207 amps (active)

10.3 Dual 25Watt amplifier card

Parameter	Detail
Amplifier	Class D amplifier with 2 x 25watt independent audio outputs
Distortion	<= 0.1% @ 25watt x 2
Frequency response (as per AS 4428.16)	400Hz to 10kHz +/- 1dB w.r.t. 1kHz 200Hz to 12kHz +/- 3dB w.r.t. 1kHz
SNR	>=70%
Speaker circuit monitoring	DC, nominal 47kΩ
Max drive voltage	100V _{RMS} @ full load
Max output current	2 x 0.250amps
Max Cable size	2.5mm ² Refer to section 8.5 for cable length guide based on cable size
Input	2 x Audio streams @ 32 kHz 16-bit audio
No. of rack slots	2
Current Consumption	0.102 amps (quiescent) and 2.47 amps (full audio load)

10.4 50Watt amplifier card

Parameter	Detail
Amplifier	Class D amplifier with 1 x 50watt independent audio outputs
Distortion	$\leq 0.1\%$ @ 50watt x 1
Frequency response (as per AS 4428.16)	400Hz to 10kHz +/- 1dB w.r.t. 1kHz 200Hz to 12kHz +/- 3dB w.r.t. 1kHz
SNR	$\geq 70\%$
Speaker circuit monitoring	DC, nominal 47k Ω
Max drive voltage	100V _{RMS} @ full load
Max output current	0.500amps
Max Cable Size	2.5mm ² Refer to section 8.6 for cable length guide based on cable size
Input	Audio stream @ 32 kHz 16-bit audio
No. of rack slots	2
Current Consumption	0.097 amps (quiescent) and 2.33 amps (full audio load)

10.5 150Watt amplifier card

Parameter	Detail	Parameter
Amplifier	Class D direct drive amplifier with 150watt audio power and 4 audio outputs	Amplifier
Minimum load resistance	67ohms	Minimum load resistance
Max Total Output	150Watt (max)	Max Total Output
Audio output 1	150Watt (max)	Audio output 1
Audio output 2 to 4	75Watt (max)	Audio output 2 to 4
Distortion	$\leq 0.3\%$ @ 150watt x 1	Distortion
Frequency response	300Hz to 10kHz +/- 1dB w.r.t. 1kHz 150Hz to 12kHz +/- 3dB w.r.t. 1kHz	Frequency response
SNR	$\geq 70\text{db}$	SNR
Speaker circuit monitoring	DC, nominal 47k Ω	Speaker circuit monitoring
Max drive voltage	100V _{RMS} @ full load	Max drive voltage
Max output current	1.500Arms	Max output current
Max Cable size	2.5mm ² Refer to section 8.7 for cable length guide based on cable size	Max Cable size
Input	Audio stream @ 32 kHz 16-bit audio	Input

10.6 Multi-purpose output card

Parameter	Detail
Outputs	8 Individual / 4 paired (voltage reversal) outputs
Rating	2 amps per output, total of 6 amps per card
Monitoring	Yes, selectable EOL 3K3 Ω , 4K7 Ω and 10K Ω
Output voltage range	12 to 28VDC
Resolution	1 VDC
Accuracy	$< 3\%$
Maximum output ripple	2% pk to pk
No of rack slots	1
Max Cable Size	1.5mm ² Refer to section 8.3.1 for cable length
Current consumption	0.030 amps (quiescent) 6.85 amps (fully loaded)

10.7 Multi-purpose interface card

Parameter	Detail
No. of Inputs	8
No. of Outputs	2
Serial port	Not configurable
FDCIE interface	Suitable only for Ampac FireFinder ^{PLUS} , RJ45 connector, CAT5/6 wiring, max length 3m
Isolated differential input with fault feedback	1 available, with 10KΩ EOL supervision, floating reference (30VDC max) with user selectable resistive fault feedback
Isolated differential inputs	3 available, with 10KΩ EOL monitoring, individual floating reference (30VDC max)
Isolated single ended inputs	4 available, with 10KΩ EOL monitoring, common floating reference (30VDC max)
Relay outputs (VFC)	2 available, max voltage 48VDC/30VAC, max current 1amp @ 30VDC, 0.5amp @ 30VAC
No. of rack slots required	1
Max input voltage (for 8 x inputs)	30VDC
Max cable size (inputs, relays)	1.5mm ²
Current consumption	0.039 amps (quiescent)

10.8 Distribution CPU card

Parameter	Detail
Relay 1	Double pole, single throw (2 x COM, 1xNo, 1xNC)
Relay 2 and 3	Single pole, double throw (COM, NO, NC)
Relay Rating	Max voltage 48VDC / 30 VAC max current 1 amp @ 30VDC, 0.5amp @ 30VAC
Ethernet	RJ45 – Primary GUI with proprietary power and transformer isolation
Ethernet	RJ45 – Remote paging consoles with proprietary power and transformer isolation
BGM	2 channels, 10kΩ impedance, max input +4 dBu, cable length max of 3m
Inputs	2 – single ended, common floating reference (max 30VDC), selectable EOL (none, 3K3, 4K7, 10K)
Max input voltage (for 2 x inputs)	30VDC
Max cable size (inputs, BGM, relays)	1.5mm ²
Micro SD	1 available
Mini USB	Device connection
Digital Audio	MLVDS, 2 x lanes of TDM bidirectional, data rate 8.192 Mbps per lane. Supports 64 audio streams at 16kHz @ 16bits / 32 audio streams at 32kHz @ 16 bits
Control signal inputs	CAN, MLVDS @ 12Mbps
No. of rack slots	1
Current consumption	0.085 amps (quiescent)

10.9 Quad radial EIS line card

Parameter	Detail
No. of handset interfaces	4
No. of MCPs per handset	2
Handset line cabling	2 core 1.5mm ² max
Handset line cabling	1 km (max)
Handset line impedance	600Ω
Handset line bandwidth	3k4Hz
No. of rack slots	1
Current consumption	0.136 amps (quiescent), 0.305 amps (active)

10.10 Dual loop EIS line card

Parameter	Detail
No. of loop interfaces	2
Handsets per loop	20
MCPs per handset	1
Loop length	1 km (max)
Signalling	Proprietary modulated digital over power
Loop cabling	2 core twisted 1.5mm ² (Unshielded Twisted Pair)
Max distance between handsets	500m
No. of racks slots	1
Current consumption	0.050 amps (quiescent – no phones connected), 0.360 amps (20 phones connected to 1 loop), 0.650 amps (40 phones - 20 phones connected to 2 loops)

10.11 Network interface card

Parameter	Detail
BGM	2 channels, 10kΩ impedance, max input +4 dBu
Network interface wiring	Multi-mode fibre, single mode fibre, 2 core cable (VDSL) or Cat 5/6
Audio channels	8 audio streams 92 x BGM, 6 x WIP handsets, 2 x paging)
No. of racks slots	1
Current consumption	0.045 amps (RJ45) 0.195 amps (OEM3087/3088 fitted) 0.087 amps (2xOEM3097, 2xOEM3094, OEM3095/3096 fitted))
Networking (node to node)	CAT 5/6 cable using standard ethernet RJ45 – 100m
	Using SFP OEM3087/3088 – 1000m (VDSL technology) 2 Core copper unshielded or shielded twisted pair with a minimum of 8-10 twists per meter suitable for distances up to 1000m. For electrically noisy environments install twisted pair with shield
	Multi-mode dual core fibre using SFP OEM3097 – 500m See Note 1*
	Single mode single core fibre using OEM3095/3096 – 10000m
	Single mode dual core fibre using OEM3094 – 10000m See Note 1*

Note 1 * items OEM 3094 and OEM 3097 are not covered by LPCB certification.

10.12 Universal rack frame

Parameter	Detail
No. of slots	16 + dedicated slot for the Distribution CPU
Max No. of dual 25Watt amplifiers	8
Max No. of 50Watt amplifiers	8
Max No. of 150Watt amplifiers	8
Max No. of 4-way radial EIS line card	16
Max No. of dual loop EIS line card	16
Max No. of Multi-purpose interface card	16
Max No. of Multi-purpose output card	6
Max No of Public Address Interface card	1
Current per rack	48 amps (max)

10.13 Power Supply

	24U Floor Mount Enclosure	13U Wall / Floor Mount Enclosure
Mains Voltage	253-195.5VAC	253-195.5VAC
Power	1200 to 3600Watt in 1200Watt increments	1200 to 2400Watt in 1200Watt increments
$P_{a\ max}$ (900W per PSU)	3 x PSU max = 2700Watt	2 x PSU max = 1800Watt
$P_{b\ max}$ (1200W per PSU)	3 x PSU max = 3600Watt	2 x PSU max = 2400Watt
P_{min}	0Watt	0 Watt
Approved battery	Power Sonic PGFT-12V180 20hr rate	Power Sonic PS-121000B
Max battery capacity	190 Amp Hr	100 Amp Hr
Min battery capacity	24 Amp Hr	24 Amp Hr
Max current draw from battery	57 Amp (1200W), 114 (2400W), 171 (3600W)	57 Amp (1200W), 114 (2400W)
Max battery resistance	60 mΩ (1200W), 30mΩ (2400W), 20mΩ (3600W)	60 mΩ (1200W), 30mΩ (2400W)
Main current	19.5 Amps	13 Amps
Main breaker	25 amps	25 amps
Internal mains wiring	2.5mm ²	2.5mm ²
Battery cabling	16mm ² (1200W), 25mm ² (2400W), 35mm ² (3600W)	16mm ² (1200W), 25mm ² (2400W)
Battery circuit breaker	60amps (1200W), 120amps (2400W), 175amps (3600W)	60amps (1200W), 120amps (2400W)

10.14 PAIC -HLI Bosch Praesensa

Parameter	Detail
Current Consumption	0.045 amps (RJ45)
No of Rack slots	1
Signalling Type	Bosch OIP (Open Interface Protocol) between Praesensa and EvacUElite runs on top of a TCP/IP connection
Connection Type	RJ45 –Cat 5/6 Ethernet TCP/IP with proprietary power and transformer isolation
DCPU Card Requirement	Special Build Version B required BRD63CPUx B with Audio Jack Fitted

10.15 Remote Paging Console

Parameter	Detail
Cabling	From DCPU, Cat5/6 Ethernet Cable Loop In Loop out. Finishing at last RPC unit. Plus Local 240V AC
Max Cable Distance between RPCs	100M. between units Note: Longer distances between RPCs would need an additional "Ethernet to SFP media switch" hardware, suitable SFPs and Power packs where needed
240V AC Plug Pack	Power required for each RPC A plug pack is supplied with each RPC unit
RPC Qty Per System (Max)	64
RPC Qty Per Node	8
Paging Zones (Max)	512
Paging Groups (Max)	512
Quiescent Current	195mA @24VDC (Screen user interface ON)
Item No	6310-RPC

11 Glossary Of Terms

ACKD	ACKNOWLEDGED
ALM	ALARM
BGM	BACKGROUND MUSIC
CAN	CONTROLLER AREA NETWORK (CAN BUS)
CN	CONNECTOR
CPU	COMMON PROCESSOR UNIT
DIS	DISABLED - ISOLATED
DGP	DATA GATHERING PANEL
EAID	EMERGENCY ALARM INITIATING DEVICE
EARTH	BUILDING EARTH
ECP	EMERGENCY CONTROL PANEL
EDS	EMERGENCY DETECTION SYSTEM
EIS	EMERGENCY INTERCOMMUNICATION SYSTEM
EICIE	EMERGENCY INTERCOM CONTROL AND INDICATING EQUIPMENT
EMO	EMERGENCY MANAGEMENT ORGANISATION
EOL	END OF LINE
EWCIIE	EMERGENCY WARNING CONTROL AND INDICATING EQUIPMENT
EWIS	EMERGENCY WARNING AND INTERCOMMUNICATION SYSTEM
EWS	EMERGENCY WARNING SYSTEM
FACP	FIRE ALARM CONTROL PANEL
FDCIE	FIRE DETECTION CONTROL AND INDICATING EQUIPMENT
FLT	FAULT
GND	GROUND (0 VOLTS) NOT EARTH
GPO	GENERAL PURPOSE OUTLET
GUI	GRAPHICAL USER INTERFACE
I/O	INPUT/OUTPUT
ILC	INTERCOMMUNICATION LINE CARD
LILC	LOOP INTERCOMMUNICATION LINE CARD
MAF	MASTER ALARM FACILITY
MCB	MASTER CONTROL BOARD
MCP	MANUAL CALL POINT
MECP	MASTER EMERGENCY CONTROL PANEL
MOV	METAL OXIDE VARISTOR (TRANSIENT PROTECTION)
MLVDS	MULTIPOINT LOW VOLTAGE DIFFERENTIAL SIGNALLING
N/C	NORMALLY CLOSED RELAY CONTACTS
N/O	NORMALLY OPENED RELAY CONTACTS
PA	PUBLIC ADDRESS
PAIC	PUBLIC ADDRESS INTERFACE CARD
PCB	PRINTED CIRCUIT BOARDS
P/S	POWER SUPPLY
PSM	POWER SUPPLY MODULE
RPC	REMOTE PAGING CONSOLE
SECP	SECONDARY EMERGENCY CONTROL PANEL
SSD	SITE SPECIFIC DATA
TB	TERMINAL BLOCK
WIP	WARDEN INTERCOM POINT

Definitions

Activating device - a device capable of being operated automatically or manually to initiate an alarm signal, eg. a detector, a manual call point, or a pressure switch.

Alarm system - facility provided in a building to give an alarm in the event of fire, civil commotion, bomb threat, leakage of toxic or noxious fumes, structural damage, or another emergency.

Alarm signal - a signal given by fire alarm, or other alarm system, at the fire indicator panel and or (EWCIE) to alert wardens and other nominated personnel to commence prescribed emergency management actions.

Alarm zone - the specific portion of a building or complex identified by a particular alarm zone facility.

Alert signal - an audible signal, or combination of audible and visible signals, from the Emergency warning system to alert wardens and other nominated personnel as necessary to commence prescribed actions.

Approved and approval - approved by, or the approval of, the Regulatory Authority concerned.

Control and indicating equipment (CIE) - a combination of control equipment and indicating equipment.

Control equipment - equipment which controls the receipts and transmission of signals within the fire detection and alarm system or initiates other action.

Emergency alarm initiating device - a manually operated device by which an alarm is given to indicate an emergency condition.

Emergency condition - is a condition which requires the evacuation of the building or zone.

Emergency control panel (ECP) - a panel which controls the emergency warning and intercommunication system (if fitted) in the building [NOTE: also see definition of master emergency control panel (MECP)].

Emergency intercommunication system (EIS) – aka **EWCIE**. A system which provides voice communication between the controlling emergency control panel (ECP) and the warden intercom point handsets (WIPS).

Emergency warning and intercommunication system (EWIS) - a combined emergency warning and intercommunication system.

Emergency warning system (EWS) - a system to provide a distinctive audible signal, verbal address, and visible signals as required, during an emergency condition.

Evacuation sequence - a pre-programmed sequence initiating alert and evacuation signals to evacuation zones as required by the Regulatory Authority.

Evacuation signal - an audible signal, or combination of audible signals, from the emergency warning system to indicate to wardens and building occupants that an evacuation or other prescribed actions are necessary.

Evacuation zone - a specific portion of a building or complex, in which the evacuation procedures are managed by one zone warden. [NOTE: this term should not be confused with the concept of 'fire alarm zone'. Fire alarm zone may or may not cover the same area as an evacuation zone.]

Factory connections - are connections made during manufacture and should not require any field alterations.

Field connections - are connections made to FDCIE, EWCIE & EICIE and ancillary equipment during installation.

Firmware - the basic operating program which is not intended to be field changeable.

House warden - a person who, during an emergency, assumes control over the building and its occupants and is the prime contact with the appropriate emergency services(s).

Interface - The interconnection between equipment which permits the transfer of data.

Main equipment - equipment essential to the operation of the system including, control equipment, amplification equipment and power supply modules.

Master alarm facility (MAF) - Part of the control and indicating equipment which receives alarm and fault signals from any alarm zone facility and initiates the common signal (alarm and/or fault) for transmission to the fire control station where appropriate. Bells and other ancillary functions may be initiated from this facility.

Master emergency control panel (MECP) - a specially designated emergency control panel (ECP) that on manual operation, takes full control of the emergency warning and intercommunication system, and overrides all other ECP's in the building.

Power Supply - that portion of the control and indicating equipment (CIE) which supplies all voltages necessary for operation of the CIE.

Regulatory Authority - an authority administering Acts of Parliament or Regulations under such Acts.

Remote auxiliary supply - power supply DC24VDC max from a remote source.

Verbal address - the mode of operation whereby verbal instruction is given from the controlling emergency control panel (ECP) to the building occupants via the loudspeaker systems.

Warden intercommunication point (WIP) - the location on a floor or evacuation zone, where equipment is provided (Red handsets) through which instructions can be received from the controlling emergency control panel (ECP) via the emergency intercommunication system.

Zone (floor) warden - a person who, during an emergency, attends the WIP handset and assumes control over a particular floor or evacuation zone under the direction of the house warden.

14 Combined FDCIE and EWCIE system Example



The combo system **illustrated above** incorporates the new AS7240.4 approved Power supply unit and a single pair of FDCIE & EWCIE back up batteries. This meets AS4428.16 system requirements. In this case a **common** ‘Essential Services’ power source connects the panel. Customer’s may continue to request Ampac manufacture combo panels comprising of two power sources and two sets of batteries. Eg system retrofits Two power sources have been a requirement (for AS2220.1 installations).

AMPAC PART NUMBER
BRD43CPIX-A

**STEP 3:
TYPICAL WIRING FOR 24U COMBO**

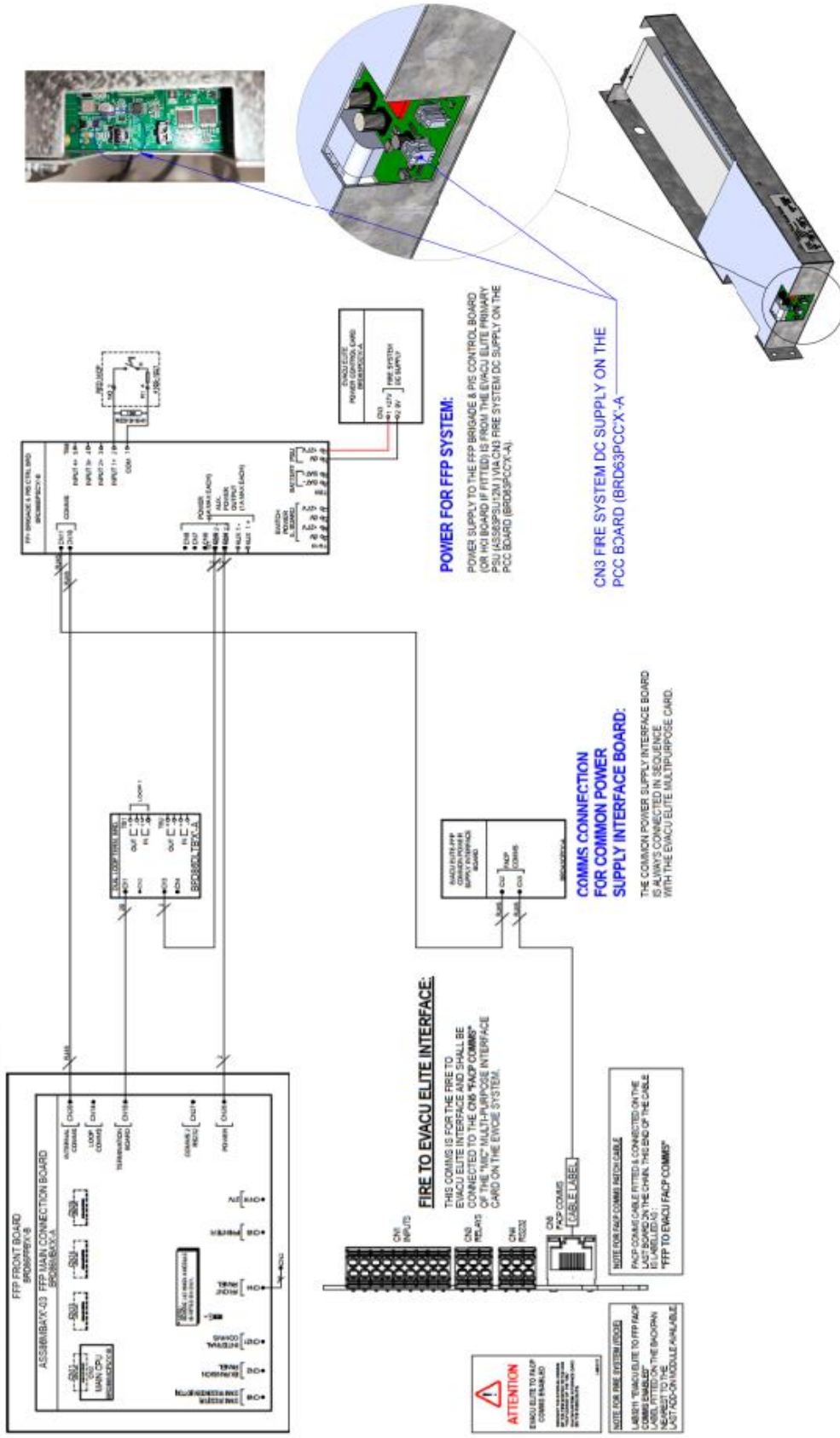

		AMPAC PTY LTD 7 Lusk Road, Buzura, Western Australia, 6021 T: +61 8 9201 9300 F: +61 8 9201 9301 E: info@ampac.com.au W: ampac.net	
DRAWING No.: BRD63CPIX-A		SHEET 3 OF 3	
BOARD INSTALLATION & WIRING		REV 0	
DRN	PT	DATE	SCALE
1603/23	1.5	16/03/23	
APPD	JR	DATE	
16/03/23		16/03/23	
TOLERANCES UNLESS OTHERWISE NOTED		WHOLE NUMBERS ±0.5	
1 DECIMAL PLACE ±0.2		2 DECIMAL PLACES ±0.1	
ANGLES ±0.5°			
DRAFTING STANDARD AS 1100:1992		DIMENSIONS IN MILLIMETRES	

Revision Control

Man 3137-1	Initial Release AS4428.16 and AS4428.4 version
Man 3137-2	Added BRE notations *
Man 3137-3	Added PSU information, Networking - Fault Finding and BGM ID revision notes
Man 3137-4	Added GUI QTY revisions. Re branded drawings and Illustrations. Added combo system PSU illustration. Updated Specifications on MOC, 150 watt Removed BRE 150-watt notations.
MAN3137-5	Added PAIC – & Reference to Audio Interface Card (future)
MAN3137-5	Added Remote Paging Console details
MAN3137-6	Changes to cabling distances on 25 & 50 watt amps

UNCONTROLLED DOCUMENT

NOTE: Due to Ampac's commitment to continuous improvement specifications may change without notice.