

Fire detection and evacuation solutions that save lives.

Reach Wireless Sounder Base

Features

- 32 switch selectable tone settings
- Four volume settings
- Bi-directional wireless communication
- Dual channel redundancy
- Easy scan & link programming
- Five year battery life

Description

The Reach Wireless Base Sounder unit is a high performance wireless sounder base that can be used as stand-alone notification device (with a blanking cap) or as a combined detection and alarm device when fitted with a Reach Optical, Heat or Multi-sensor detector. The unit has as standard 16+16 recognised sounder Alert & Evacuate tones and 4 levels of volume adjustment, all of which can be easily configured on site. It is powered by standard lithium batteries utilising well proven adaptive radio signal processing algorithms to ensure the highest levels of life safety and reliability.

Communication

Reach Wireless Devices use 'radio-frequency' wireless communication to connect to the Loop Interface.

The Loop Interface translates the wireless communication into wired XP95 protocol communication, with each device addressable individually by the fire panel. Refer Loop-Interface datasheet for further information.

Maintenance and Service

Maintenance must be performed in accordance with all applicable standards. Clean the detector externally using a soft damp cloth.

Batteries

Reach Wireless devices are supplied with two CR123 batteries, battery A and B. The device switches periodically between the two batteries on a controlled sequence. For correct operation of the device, both batteries are required with adequate capacity reserves.

When battery A reaches a low power threshold, it will trigger a fault. This fault requires both batteries to be replaced in every instance as both batteries should be discharging equally.

When one (or both) batteries lack power, the Loop-Interface receives a low battery message and will signal this event on its in-built display, as well as relay the low battery message to the fire control panel. The battery fault will also be signaled by the device itself through its LED indicators if programmed (see table 1).



Specifications

Number of Tone Pairs	16 (see table 6)
Volume Levels	Four (see table 3)
Sound Output (Typical)	88 - 91 dBA (tone dependant)
Communication Range between Loop-Interface and Devices	100 m (in open space)
Field Device Radio Frequency Channel Pairs	22 pairs
Radiated Power	14 dBm (25 mW)
Battery Type	2x VARTA CR123A Lithium 3 V, 1250mAh typical
Battery Lifespan	5 years in normal operation with good signal strength (no dropped messages)
Operating Temperature	-10°C to +55°C
Maximum Relative Humidity	95% (non-condensing)
IP Rating	IP 21C (Type A Indoor Use)
Standards and approvals	EN54-3, EN54-25 AS7240.3, AS7240.25
Dimensions	129 mm diameter x 54 mm height
Weight	190 g (including batteries)

Item Numbers

	Australia	International
Reach Sounder Base	4107-8401	RW1300-110APO
Reach Sounder Base (black)	4107-8421	

All data is supplied subject to change without notice. Specifications are typical at 24 V, 25°C and 50% RH unless otherwise stated.

Fire detection and evacuation solutions that save lives.

Reach Wireless Sounder Base

Status LED

The Reach Wireless Sounder Base includes a 360° LED indicator which to indicate status conditions. See table 1.

Table 1 - Reach Device Status & LED Indication

Device Status	LED Indication	
	Tamper Not Activated	Tamper Activated
Power Up	Blinks green four times	
Power Up (dip-switch ON)	Blinks red four times	
Entering Wake-Up	Blinks alternatively green/red four times	
Link Success	Blinks green four times, then repeats	
Link Failure	Enters wake-up mode and signals 'Entering wake-up mode' following this failure	
Normal Condition	LED off	LED off
Activation	LED off	Red on
Battery Faults	LED off	Amber blinking every 5s
Tamper Fault	LED off	
Replaced	Blinks amber two times	

Device Addressing

Device addressing is handled by the Reach Wireless Loop-Interface device.

Devices are soft-addressed automatically when pairing with the Loop Interface and can be changed manually. Hard-addressing using XPERT cards are not required.

Table 2 - Reach DIP Switch Functionality

DIP Switch Number	DIP Switch Group Function	Notes
1	Tone Selection	Check Tone Table (Table 5)
2		
3		
4		
5		
6	Volume Selection	Check Volume Table (Table 3)
7		
8	High/Low Power LED Output	N/A

Tone & Volume Selection DIP Switch Settings

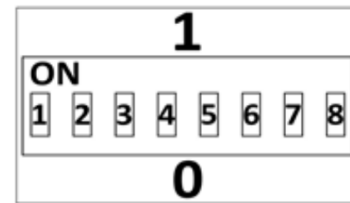

Table 3: Reach Volume Table

Volume	DIP Configuration
High*	11
Medium High	01
Medium Low	10
Low	00

*EN54-3 certified with tone selection number 1 to 7, refer Tone Table. Tones 1, 8, 9 & 15 certified to ISO AS7240.3-2021

Base Compatibility

This device is compatible with the following products

Table 4 - Reach Detector Comptability

Product Name	Australia	International
Reach Heat Detector	4106-5402	RW1000-400APO
Reach Optical Detector	4106-5401	RW1000-600APO
Reach Multi-sensor Detector	4106-5403	RW1000-700APO
Reach AV Base Cap - White	4107-8404	RW1300-010
Reach AV Base Cap - Red	4107-8405	RW1300-020

Fire detection and evacuation solutions that save lives.

Reach Wireless Sounder Base

Tamper detection

Reach Wireless devices contain an anti-tamper mechanism. In the event of removal from its base, it sends a tamper detection message to the Loop-Interface.

Tamper detection is not signaled visually by the device LED.

EMC Directive 2014/30/EU

Reach Wireless Sounder Base complies with the essential requirements of the EMC Directive 2014/30/EU, provided that it is used as described in this datasheet.

A copy of the Declaration of Conformity is available on request.

Conformity of the Reach Wireless Sounder Base with the EMC Directive does not confer compliance with the directive on any apparatus or systems connected to it.

Construction Products Regulation (EU) 305/2011

The Reach Wireless Sounder Base complies with the essential requirements of the Construction Products Regulation (EU) 305/2011

A copy of the Declaration of Performance is available on request.

Sound Pressure Levels

Tones 1, 8, 9 & 15 are certified to ISO AS7240.3-2021.

Sound pressure levels are recorded in dB with the device in located in its normal operating position at a distance of 1m.

Tone No.	165°	135°	105°	75°	45°	15°
1 - Evac	87.6	85.9	90.1	91.7	84.1	88.1
1 - Alert	85.3	84.8	86.4	88.7	83.9	82.6
8 - Evac	89.0	84.7	90.5	91.9	86.2	87.6
8 - Alert	86.2	85.4	86.4	90.4	87.0	87.7
9 - Evac	90.3	87.5	91.8	92.4	88.0	89.7
9 - Alert	86.2	85.5	87.2	90.9	87.0	88.0
15 - Evac	81.5	80.4	82.6	85.2	85.4	84.1
15 - Alert	82.4	80.5	81.7	84.5	84.4	84.2



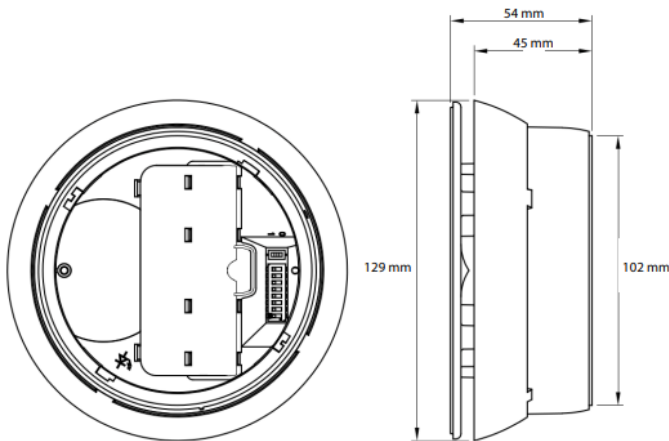







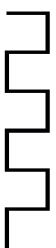

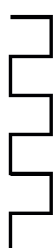



















Dimensions



Approvals



Tone Table

Tone Pair Number	DIP Switch Value	Primary Tone (Evacuation)			Secondary Tone (Alert)			Tone Period (sync.)
		Temporal Pattern Icon	Temporal Pattern Description	Frequencies	Temporal Pattern Icon	Temporal Pattern Description	Frequencies	
1	00000		Apollo Fire Systems Evacuate Tone	650Hz for 0.5s, 925Hz for 0.5s		Apollo Fire Systems Alert Tone	1s off, 925Hz for 1s	2
2	00001		Alternating warble (Hochiki & Fullcon)	925Hz for 0.25s, 626Hz for 0.25s		Continuous (Hochiki & Fullcon)	925Hz	2
3	00010		Sweep (med) @ 1Hz	800Hz - 970Hz @ 1Hz		Continuous	970Hz Continuous (BS5839-1:2002)	2
4	00011		Sweep (fast) @ 9Hz	2500Hz-2850Hz @ 9Hz		Continuous	2850Hz continuous	2
5	00100		Netherlands – NEN 2575:2000 (Dutch Slow Whoop)	500 – 1200Hz for 3.5s, 0.5s OFF		Continuous	825Hz continuous	4
6	00101		German DIN 33 404	1200Hz - 500Hz Sweep 1s (1Hz)		Continuous	825Hz Continuous	2
7	00110		Swedish Fire Signal	660Hz 0.15s ON, 0.15s OFF		Swedish All Clear	660Hz Continuous	6
8	00111		Australia Fast-rise Sweep (AS1670.4-2004 Evacuation tone)	3x (500Hz - 1200Hz for 0.5s, 0.5s off), 1s off		Australia AS1670.4-2004 Alert tone	420Hz 0.625s ON, 0.625s OFF	4
9	01000		New Zealand Slow-rise Sweep Evacuation Tone (NZS 4512)	500Hz - 1200Hz, 3.75s Sweep, 0.25s OFF		New Zealand Alert Tone (NZS 4512)	420Hz 0.625s ON, 0.625s OFF	4
10	01001		US Temporal LF (ISO 8201) Low tone	3x(970Hz 0.5s ON, 0.5s OFF), 1s OFF		Continuous	970Hz Continuous	4
11	01010		US Temporal HF ISO 8201 High tone	3x(2850Hz 0.5s ON, 0.5s OFF), 1s off		Continuous	2850Hz continuous	4
12	01011		Simulated Bell - Continuous	827Hz for 16ms followed by 990Hz for 16ms.		Simulated Bell - Intermitent	827Hz for 16ms followed by 990Hz for 16ms for 1s then 1s off.	2
13	01100		Emergency Warning Siren	600Hz - 1200Hz 4s followed by 1200 - 600Hz 4s		Emergency Warning Siren All Clear	1200Hz Continuous	2
14	01101		France – AFNOR NF S 32 001	554Hz, 0.1s, 440Hz, 0.4s		Continuous	970Hz Continuous	2
15	01110		Australia Evacuation (AS7240-3)	520Hz 0.5s ON, 0.5s OFF x 3, 1s OFF		Australia Alert (AS7240-3)	520Hz +4.5%, 0.5s ON, 3.5s OFF	4
16	10000		Silent Tone (Reach Wireless ONLY)	0Hz Continuous		Silent Tone (Reach Wireless ONLY)	0Hz Continuous	2